

 **SIAFA**<sup>®</sup>  
[www.siafa.com.ar](http://www.siafa.com.ar)







 **SIAFA**<sup>®</sup>  
[www.siafa.com.ar](http://www.siafa.com.ar)



# ENVIRONMENTAL MONITOR

## EVM SERIES

### Dangers, Warnings, & Cautions

	<p style="text-align: center;"><b>DANGER!</b></p> <p><b><i>Failure to observe the following procedures may result in serious personal injury:</i></b></p> <ul style="list-style-type: none"> <li>• Not for use in Explosive or Hazardous locations. This product is <b>NOT</b> Intrinsically Safe.</li> <li>• Contains built-in lithium ion battery pack. <b>DO NOT</b> incinerate or dispose of in fire.</li> <li>• <b>DO NOT</b> disassemble, alter, or re-construct the li-ion battery.</li> <li>• Contains Class 3B visible laser radiation source (658 nm, nominal 5 mW). <b>DO NOT</b> look directly into beam or view with telescopic devices.</li> <li>• This instrument will <b>NOT</b> detect natural gas.</li> </ul>
	<p style="text-align: center;"><b>WARNING!</b></p> <ul style="list-style-type: none"> <li>• Read the manual before operation.</li> <li>• <b>DO NOT</b> store in temperatures exceeding 60°C (140°F) and in direct sunlight.</li> <li>• <b>DO NOT</b> immerse in liquids.</li> <li>• The Sensors and batteries in this instrument have limited shelf-life, even if never used.</li> <li>• <b>DO NOT</b> disassemble, service, or clean the optical engine internal components while power is applied. The laser source can hurt you.</li> </ul>
	<p style="text-align: center;"><b>Caution!</b></p> <p><b>General</b></p> <ul style="list-style-type: none"> <li>• Condensation may damage your instrument and its sensors.</li> <li>• A non-condensing environment is required for proper measurements.</li> <li>• <b>DO NOT</b> charge batteries outside the range of 0°C to 40°C (32°F to 104°F).</li> <li>• Battery run-time may be somewhat reduced at lower than 20°C (68°F) temperatures.</li> </ul>
	<p style="text-align: center;"><b>Caution!</b></p> <p><b>Temp/RH/Dew Point</b></p> <p>The internal Temp/RH sensor in this instrument is not designed for use in bright sunlight or in the presence of a strong radiant heat sources. It is intended primarily for indoor use. It is not equivalent to a protected dry-bulb thermometer.</p>

	<b>Caution!</b>
	<p><b>PM/dust</b></p> <ul style="list-style-type: none"> <li>• Clean the optical engine mirror with a soft cloth, if it is dirty. Scratches will affect performance.</li> <li>• Avoid measuring wet particles, fogs, and liquid mists that will tend to cling to the impactor, optical engine, tubing, and pump surfaces.</li> <li>• Avoid oily mists as found near some machining operations.</li> <li>• This monitor is designed to measure dry particulates, not filaments.</li> <li>• <b>DO NOT</b> attempt to measure Asbestos with this instrument.</li> <li>• Keep a "Pump Protection Filter" or other gravimetric filter in place to help prolong the life of the pump.</li> <li>• You must check and calibrate the flow rate, when using this device as a (gravimetric) sampling pump.</li> </ul>
	<b>Caution!</b>
	<p><b>CO<sub>2</sub></b></p> <p>Avoid exposure to condensation, fogs, and liquid mists that can contaminate the optical path inside the CO<sub>2</sub> sensor.</p>
	<b>Caution!</b>
	<p><b>PID</b></p> <ul style="list-style-type: none"> <li>• This instrument cannot detect methane gas.</li> <li>• For best sensor life, avoid acidic condensing gases.</li> <li>• The presence of moisture can affect performance of the PID.</li> </ul>
	<b>Caution!</b>
	<p><b>Toxic</b></p> <p>Beware of certain cross-sensitivities when measuring toxic gas levels. Readings can be nonspecific in the presence of certain cross-contaminant gases.</p>
	<b>Caution!</b>
	<p><b>ir velocity</b></p> <p>The tip of the Air velocity probe is very fragile.</p>



## FCC Compliance Statement

This equipment has been tested and found to comply with the limits for a Class B digital device, pursuant to Part 15 of the FCC rules. These limits are designed to provide reasonable protection against harmful interference when the equipment is operated in a commercial or residential environment. This equipment generates, uses and can radiate radio frequency energy and, if not installed and used in accordance with the instruction manual, may cause harmful interference to radio communications. If harmful interference occurs, the user will be required to correct the interference at his or her expense.



# Table of Contents

<b>Dangers, Warnings, &amp; Cautions</b> .....	iii	Setting Logging and Viewing Run Time .....	23
<b>Table of Contents</b> .....	vii	PID Sensor Setup .....	25
<b>Introduction</b> .....	1	Changing Units (Temperature, Particulates, PID, and Air Velocity) .....	27
<b>Particulate Sampling (Aerosols/Dust Vapors)</b> .....	2	Setting up Particulate Settings .....	27
Particulate Path .....	2	Setting Profiles (Particulate Correction Factors) .....	28
Particulate Sizes .....	3	How Particulate Factors are Adjusted and Calculated ..	28
Particulates and Cut-Point .....	4	Dust Correction Factors (Profiles) .....	28
Collecting/Sensing the Particulates .....	4	Particulate Pump: Enable or Disable .....	30
Gravimetric Sampling .....	4	Resetting the Gravimetric Filter .....	30
Pump .....	4	Auxiliary Input/Output .....	31
<b>Gas Sensors Sampling</b> .....	4	Digital Output .....	31
Gas Sensors and Path .....	5	Air Velocity .....	33
<b>Volatile Organic Compounds (VOCs) Sampling</b> .....	6	Analog-out .....	33
<b>Temperature, Relative Humidity, Dew Point</b> .....	6	Restoring Default Factory Settings .....	34
<b>What the Standards Say</b> .....	6	Backlight Setting .....	36
Resources .....	7	Resetting the EVM .....	36
<b>EVM Series</b> .....	8	Lock/Secure Run and/or Setup .....	36
Applications .....	8	Unlock run and/or setup .....	38
Models Explained .....	9	Auto-run .....	38
<b>Getting Started</b> .....	11	Auto-run and timed-run mode .....	38
<b>Checking the Equipment</b> .....	11	Auto-Run with Date Mode .....	39
<b>Display and Keypad</b> .....	12	Auto-Run with Day of Week (DOW) Mode .....	40
Diagram .....	12	<b>Calibrate Sensors</b> .....	43
Keypad description .....	12	<b>Placement and Calibration of Sensors</b> .....	43
<b>Turning on</b> .....	13	Calibrating sensors include: .....	43
Start Screen Explanation .....	13	Inserting and Removing Sensors .....	43
Navigating .....	14	Calibrating Particulates .....	44
Indicators/Icons on the display .....	14	Impactor and use .....	45
<b>Turning Off</b> .....	15	Adjusting the Impactor/Turret Setting .....	46
<b>Instrument Information</b> .....	15	Particulates Calibration (Zero Cal) .....	47
Unit Information Screen .....	15	Particulate Advanced Calibration (Gravimetric) .....	51
<b>TSI Detection Management Software DMS</b> .....	17	Gravimetric Calibration Overview .....	52
<b>Communicating</b> .....	17	Performing a Gravimetric Calibration .....	52
Powering and Outputs on the EVM .....	17	Pump Flow Rate Calibration .....	53
Battery .....	17	Toxic Gas Sensors .....	54
Charging .....	18	Cross Sensitivity .....	55
Outputs .....	18	How Sensors Operate .....	55
<b>Setting up the Environmental Monitor</b> .....	19	Quality Calibrations .....	55
<b>Setting up Parameters via the Keypad</b> .....	19	About Sensors and Cal Storage .....	55
Time and Date Setting .....	19	Calibration History and Sensor Serial Numbers .....	55
Checking Battery Power .....	20	Applying a Gas Sensor .....	56
Display: Language, Contrast, and Key Click .....	22	Calibrating Toxic Gas Sensors .....	56
		Toxic Gas Zero Calibration .....	57
		Ozone Calibration for Zero and Span .....	57
		Toxic Gas Span Calibration .....	59
		Calibrating CO <sub>2</sub> AND O <sub>2</sub> .....	60
		O <sub>2</sub> Accuracy .....	60

Calibrating Photo-Ionization Detector (PID) Sensor.....	63	<b>EVM Reports and Printing.....</b>	<b>96</b>
PID parts per million (ppm) zero calibration.....	63	Customizing Reports.....	97
PID parts per billion (ppb) zero calibration.....	63	EVM Setup.....	98
PID Span Calibration.....	64	Saving and Sending Configurations.....	98
Calibrating Relative Humidity and Temperature.....	66	General EVM Setup.....	99
Calibration History.....	67	EVM General Parameters Table.....	99
Verify Calibration and Drifting Analysis.....	68	EVM and Logging Settings.....	100
<b>Measuring and Viewing.....</b>	<b>71</b>	EVM Logging Parameters Table.....	101
<b>Overview of Running a Session.....</b>	<b>71</b>	EVM and Auto-Run Setting.....	101
Quick Help.....	71	Timed-Run and Auto-Run Setting.....	102
<b>Measuring.....</b>	<b>71</b>	Date and Auto-Run Setting.....	102
Understanding What Data is Stored.....	72	Day of Week and Auto-Run Setting.....	103
Summary Data.....	72	EVM and Security Settings.....	104
Logged Data/Time History.....	72	EVM and Triggering Settings.....	104
Running and Stopping.....	73	EVM and Particulate Settings.....	106
<b>Measurement Screens and Navigation.....</b>	<b>74</b>	EVM and Particulates Setup.....	106
Unit defined.....	74	EVM Firmware Update.....	107
About the Measurement Soft Keys.....	75	<b>Maintenance and Cleaning.....</b>	<b>109</b>
<b>Particulate Measurement Screen.....</b>	<b>76</b>	<b>Overview.....</b>	<b>109</b>
Impactors and Particulate Measuring.....	76	PID Sensor.....	109
Extending Run-Time for PM Measurements.....	76	Removing and Installing PID Sensor.....	110
Changing Particulate Measurements.....	77	Maintenance and Cleaning Overview of PID.....	111
<b>Relative Humidity and Temperature Measurements.....</b>	<b>78</b>	Cleaning PID Sensor.....	111
Relative Humidity and Temperature Screen.....	78	<b>Optical Engine: Maintenance and Cleaning.....</b>	<b>113</b>
<b>Gas Measurements.....</b>	<b>79</b>	<b>Impactor Care.....</b>	<b>116</b>
Gas Screen.....	79	Impactors and When To Clean.....	117
<b>Composite Measurement.....</b>	<b>80</b>	<b>Gravimetric Cassette and Filter Paper.....</b>	<b>117</b>
Composite Screens.....	80	<b>Specifications.....</b>	<b>119</b>
<b>Air Velocity Measurement Screen.....</b>	<b>81</b>	<b>Particulate Sensor.....</b>	<b>119</b>
<b>Summary Data.....</b>	<b>82</b>	<b>Volatile Organic Compounds (VOCs) Gas Detector (PID Sensor).....</b>	<b>119</b>
Viewing Details in the Measurement Screen.....	82	<b>Carbon Dioxide Sensor.....</b>	<b>120</b>
<b>Trend Data.....</b>	<b>83</b>	<b>Relative Humidity Sensor.....</b>	<b>120</b>
Viewing trend data in the measurement screen.....	83	<b>Temperature Sensor.....</b>	<b>120</b>
<b>Past Session.....</b>	<b>84</b>	<b>Toxic Gas Sensors.....</b>	<b>121</b>
Summary Data Screen.....	84	<b>Air Velocity Accessory (Optional – Air Probe 10).....</b>	<b>121</b>
<b>File System Menu.....</b>	<b>86</b>	<b>Displayed Data.....</b>	<b>121</b>
Deleting Sessions Individually.....	86	<b>Electrical Characteristics.....</b>	<b>122</b>
Delete All Sessions.....	87	<b>Environmental effects.....</b>	<b>122</b>
Memory Remaining and File Properties.....	88	<b>Physical characteristics.....</b>	<b>122</b>
Estimated Run Time.....	89	<b>Measurements units.....</b>	<b>122</b>
<b>Detection Management Software.....</b>	<b>91</b>	<b>Operating Modes.....</b>	<b>123</b>
<b>Environmental Monitor Communication.....</b>	<b>91</b>	<b>Time Constants.....</b>	<b>123</b>
<b>Downloading Data with the EVM.....</b>	<b>93</b>	<b>Special Functions.....</b>	<b>123</b>
<b>EVM: Viewing Data.....</b>	<b>93</b>		
Selecting a session/study.....	93		
EVM Panel Layout View (PLV) Page.....	94		



<b>Estimated Logged Run Times</b> .....	<b>124</b>	Particulate Measurements.....	151
Standard EVM-7 (Memory and logged time).....	124	Gravimetric Sample (optional for particulate calibration).....	153
Standard EVM-4 (Memory and logged time).....	125	Toxic Sensor Measurements.....	154
Standard EVM-3 (Memory and logged time).....	127	Pump/Airflow Measurements.....	155
<b>Accessories: Replacement and Optional Parts</b> .....	<b>128</b>	Digital Output (using stereo plug & diagram) .....	156
<b>Customer Service</b> .....	<b>131</b>	PID Questions (for Volatile organic compound measurements) .....	157
<b>Technical Support Contacts</b> .....	<b>131</b>	Power.....	158
<b>Service Contact Information</b> .....	<b>131</b>	Alarm Outputs.....	158
<b>Returning for Service</b> .....	<b>132</b>	General: Mechanical.....	159
<b>Calibration</b> .....	<b>132</b>	CO <sub>2</sub> Sensor and how to reorder .....	159
<b>Warranty</b> .....	<b>133</b>	CO <sub>2</sub> Sensor and how to reorder ( <i>continued</i> ).....	160
<b>Glossary of Terms</b> .....	<b>135</b>	Calibrating Sensors .....	160
<b>Appendix C</b> .....	<b>141</b>	<b>Appendix E</b> .....	<b>163</b>
<b>PID sensor and correction factors tables</b> .....	<b>141</b>	<b>System Errors Displayed on the EVM Series</b> .....	<b>163</b>
<b>Appendix D</b> .....	<b>151</b>	<b>INDEX</b> .....	<b>165</b>
<b>Frequently Asked Questions (FAQs)</b> .....	<b>151</b>		

## List of Figures

Figure 1-1: Particulate path diagram .....	2	Figure 3-18: Restoring default calibrations .....	35
Figure 1-2: Particulates and diameter size .....	3	Figure 3-19: Backlight key .....	36
Figure 2-1: Identifying your equipment .....	11	Figure 3-20: Lock Soft key .....	37
Figure 2-2: EVM keypad and display explained .....	12	Figure 3-21: Setting lock/secure .....	37
Figure 2-3: Start screen defined .....	13	Figure 3-22: Selecting auto-run with timed-run mode.....	38
Figure 2-4: Unit Information screen .....	15	Figure 3-23: Setting timed-run and duration.....	39
Figure 2-5: Selecting Unit Info. Sensors.....	16	Figure 3-24: Selecting auto-run with date mode.....	39
Figure 2-6: Viewing installed sensors .....	16	Figure 3-25: Setting auto-run date mode.....	40
Figure 2-7: Communicating with DMS via USB cable .....	17	Figure 3-26: Setting auto-run DOW mode .....	41
Figure 2-8: USB, power jack and digital output port .....	18	Figure 4-1: Sensor housing and manifold .....	43
Figure 3-1: Time-Date screen parameters .....	20	Figure 4-2: Sensors' locations .....	44
Figure 3-2: Start screen .....	21	Figure 4-3: How the impactor functions .....	45
Figure 3-3: Battery screen .....	21	Figure 4-4: PM2.5 impactor setting example .....	46
Figure 3-4: Screen display settings .....	22	Figure 4-5: Adjusting impactor/turret setting .....	47
Figure 3-5: Logging screen.....	24	Figure 4-6: Particulate zero cal with HEPA filter.....	48
Figure 3-6: Estimated run time for logging screen.....	25	Figure 4-7: Selecting calibration screen .....	48
Figure 3-7: PID correction factor.....	26	Figure 4-8: Particulate cal screen .....	49
Figure 3-8: PID correction factor displayed on measurement screens.....	26	Figure 4-9: Particulate calibration and ready screen .....	49
Figure 3-9: Units screen .....	27	Figure 4-10: Particulate calibration and waiting screen .....	50
Figure 3-10: Edit profiles for dust calibration .....	29	Figure 4-11: Particulate calibration pause screen .....	50
Figure 3-11: Entering a profile for particulate calibration.....	29	Figure 4-12: Zero Cal set for Particulates .....	51
Figure 3-12: Particulate setup screen.....	30	Figure 4-13: Reset gravimetric setting.....	52
Figure 3-13: Configuring digital output.....	32	Figure 4-14: Pump flow rate calibration .....	53
Figure 3-14: Air Velocity setting .....	33	Figure 4-15: Flow Rate Calibration .....	54
Figure 3-15: Analog out results with temperature as output.....	33	Figure 4-16: Calibration history for EVM.....	55
Figure 3-16: Analog-Out screen .....	34	Figure 4-17: Applying a gas sensor .....	56
Figure 3-17: Defaults screen (restoring factory settings)....	34	Figure 4-18: Selecting sensor for calibration process.....	57
		Figure 4-19: Calibration zero screen .....	58
		Figure 4-20: Calibration zero pause screen.....	58

Figure 4-21: Span Calibration .....	59	Figure 5-17: Summary screen of a past session .....	86
Figure 4-22: Saved Calibration screen .....	60	Figure 5-18: Delete session message .....	87
Figure 4-23: Selecting a calibration sensor .....	61	Figure 5-19: Delete all sessions message .....	87
Figure 4-24: Calibration CO2 ready screen .....	61	Figure 5-20: File Systems properties screen .....	88
Figure 4-25: Setting CO <sub>2</sub> Span Cal screen .....	62	Figure 5-21: Viewing estimated run time .....	89
Figure 4-26: Saved Calibration .....	62	Figure 6: Communicating with the EVM and DMS .....	91
Figure 4-27: Selecting PID sensor for calibration process .....	63	Figure 6-1: DMS Start page and Setup/Download options .....	92
Figure 4-28: Calibration mode screen .....	64	Figure 6-2: EVM and downloading .....	93
Figure 4-29: PID Calibration Span soft key .....	65	Figure 6-3: Data finder page .....	94
Figure 4-30: Saved Calibration screen .....	66	Figure 6-4: Charts and Graphs (panels) .....	95
Figure 4-31: Temperature calibration .....	67	Figure 6-5: EVM data in a report format .....	96
Figure 4-32: Calibration History screen .....	67	Figure 6-6: Customizing DMS reports .....	97
Figure 4-33: Calibrate offset verify screen for PID sensor .....	68	Figure 6-7: Saving and sending EVM setups .....	98
Figure 4-34: Calibrating PID .....	68	Figure 6-8: General EVM setups .....	99
Figure 5-1: Quick help list for running a study .....	71	Figure 6-9: Logging EVM setups .....	101
Figure 5-2: Sample summary data from DMS reporting .....	72	Figure 6-10: EVM Timed-Run Auto-Run setting .....	102
Figure 5-3: Sample time history data (or logged data) chart .....	73	Figure 6-11: EVM Auto-Run with Date setting .....	103
Figure 5-4: Composite measurement screen in run mode .....	73	Figure 6-12: EVM Auto-Run with Day of Week setting .....	103
Figure 5-5: Example of measurement soft key menus .....	75	Figure 6-13: EVM Auto-Run with Day of Week setting .....	104
Figure 5-6: Particulate Measurement screen .....	76	Figure 6-14: EVM Triggering setup .....	105
Figure 5-7: Selecting a measurement calculation .....	77	Figure 6-15: EVM Auto-Run with Day of Week .....	106
Figure 5-8: RH and temperature measurement screen .....	78	Figure 7-1: Removing and inserting PID sensor .....	110
Figure 5-9: Gas measurement screen .....	79	Figure 7-2: Removing intelligent-sensor casing with PID .....	111
Figure 5-10: Composite measurement screen .....	80	Figure 7-3: Removing the lamp with removal tool .....	112
Figure 5-11: Attaching Air Probe and measuring Air velocity .....	81	Figure 7-4: Remove/insert PID sensor with lamp & pellet .....	112
Figure 5-12: Details of the composite measurement screen .....	82	Figure 7-5: PID sensor cleaning kit .....	112
Figure 5-13: Selecting Trend soft key .....	83	Figure 7-6: Fitting/Inserting the lamp and pellet .....	113
Figure 5-14: Trend Screen for PM (Dust) .....	84	Figure 7-7: Optical engine and cleaning .....	114
Figure 5-15: Past session screen .....	84	Figure 7-8: Cleaning the optical engine .....	115
Figure 5-16: Past Session with Files selected .....	85	Figure 7-9: When to clean impactors .....	117
		Figure 7-10: Gravimetric cassette and filter paper maintenance .....	117

## List of Tables

Table 2-1: Keypad/user interface explained .....	13	Table 4-1: Cross-sensitivity table of interfering gas .....	55
Table 2-2: Indicators (i.e., run, stop, battery, Altf) .....	14	Table 4-2: Gas calibration soft keys explained .....	58
Table 3-1: Display settings explained .....	22	Table 5-1: Unit abbreviations .....	74
Table 3-2: Logged intervals and selecting logged measurements .....	23	Table 5-2: Measurement soft keys explained .....	75
Table 3-3: Digital out/Logic settings .....	31	Table 5-3: Measurement values explained .....	78
		Table 5-4: Past session files soft keys explained .....	85

# Introduction

The EPA (Environmental Protection Agency) conducted a study over the last 25 years (1975-2000) and determined that 107 measurable air pollutants, specifically carcinogens, exist in working environments. Combined with the advent of closed windows, modern office buildings and various cleaning solvents, the outcome has been energy efficient buildings and homes which contain levels of carcinogens. At high levels, this is known as “Sick Building syndrome” and can cause acute effects such as headaches, eye/nose/throat irritation, dry cough or itchy skin, fatigue, and trouble concentrating just to name a few. Area monitoring or spot checking for high levels of pollutants, such as particulates, VOCs, and toxics, should be a common practice to ensure good indoor air quality exists in your environment. If poor air quality is determined, engineering controls such as proper air ventilation and the removal of toxic gases, would be put into place in order to provide an adequate working/living environment.

The EVM is equipped to measure several different airborne containments or air pollutant applications including:

- Particulate matter sampling (dust monitoring)
- Gas sampling
- Temperature sampling
- Relative Humidity and Dew Point sampling

To get you started quickly with the EVM, the first chapter is dedicated to introducing basic particulate matter and toxic gas information. The subsequent chapters will guide you through setting up the EVM, running studies, and assessing your results with easy to follow steps and illustrations.



## Caution

The EVM is intended to measure gases that are potentially dangerous to human health. To help ensure worker safety through the proper use of your unit, it is important that you not only read but also understand the contents of this manual. Familiarize yourself with the unit before using it in a potentially hazardous situation.

## Particulate Sampling (Aerosols/Dust Vapors)

The EVM is a portable-area monitoring instrument with a laser-photometer that measures and stores concentration levels of airborne-dust over time. It is designed to measure and help you identify the air pollutants, existing as matter (gases and aerosols) in the environment. The methodology used entails a handful of components including: an air inlet, the impactor (which is the particle size selector), the collection of particulates, gravimetric sampling, and the pump which are addressed in the upcoming sections.

### Particulate Path

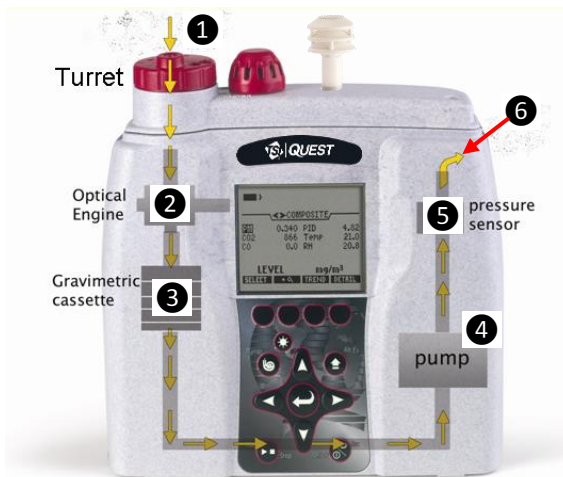
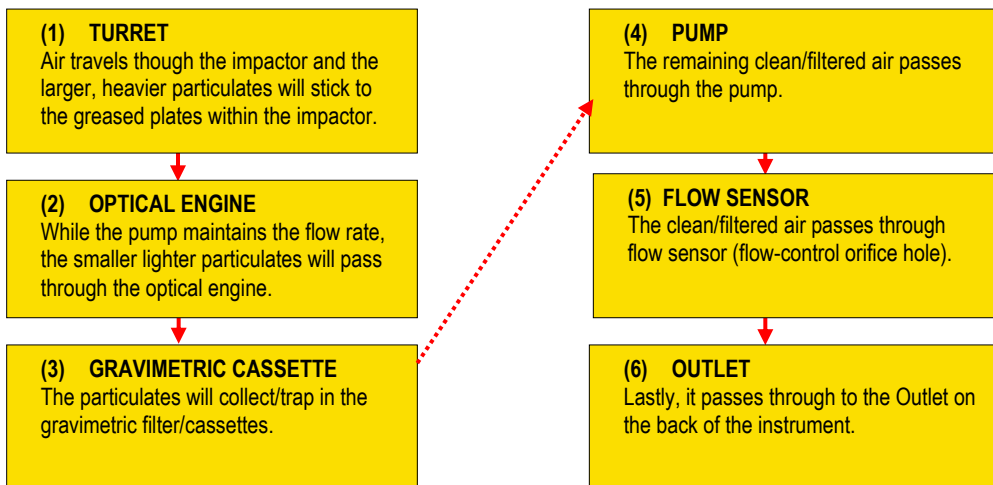

Figure 1-1: Particulate path diagram

## Particulate Sizes

Aerosols and gases are experienced in industrial processes, workplaces, and in everyday life. Keeping in mind that inhalable dust is 100 microns and smaller, this dust is usually filtered through the hairs and membranes in your sinuses. 10 microns and smaller is considered “thoracic”, 4-10 microns is “inhalable” reaching into your windpipe and other regions, and 4 microns and smaller is “respirable”. These particulate sizes will represent what you will be measuring.

The figure below identifies different types and sizes of particulates and how it affects the human body.

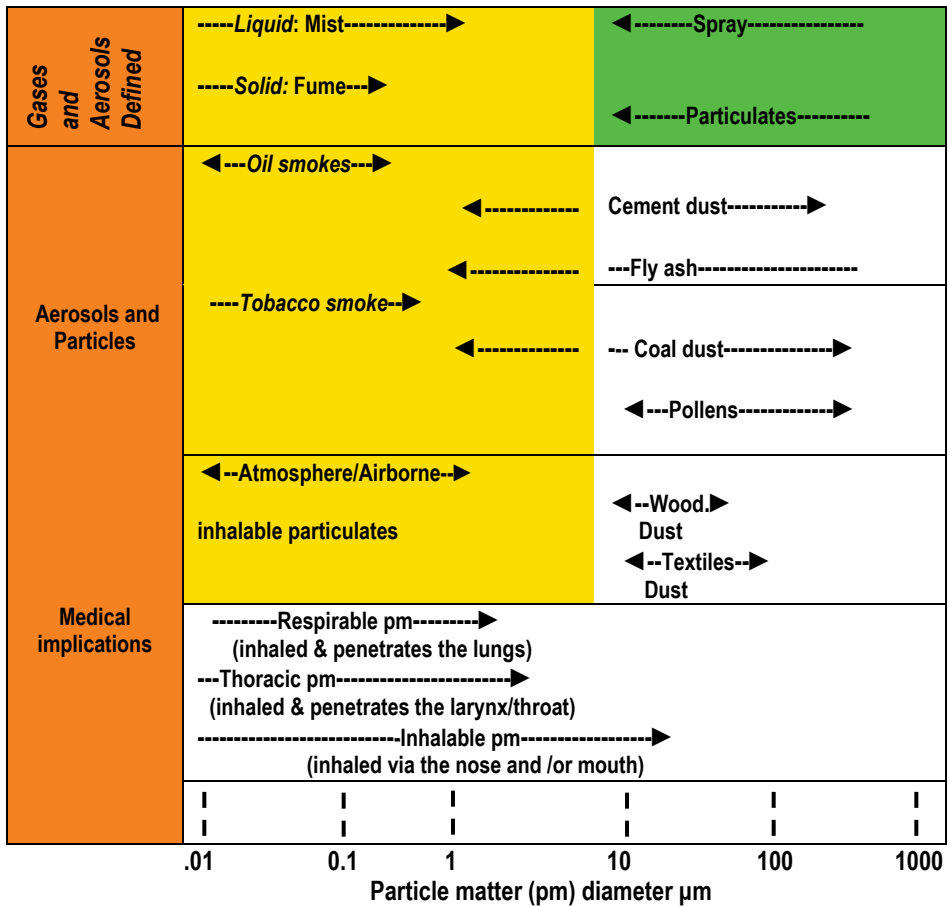

Figure 1-2: Particulates and diameter size

## Particulates and Cut-Point

In consideration of how the size of particulates affect the human body, it is important to select a particulate size cut-point. Essentially, the particle size selector on the EVM is a top-mounted rotary impactor. Based on your setting, it will filter out all particulates at or above the selected size. The instrument has four settings which include 2.5  $\mu\text{m}$ , 4  $\mu\text{m}$ , 10  $\mu\text{m}$ , or none (100  $\mu\text{m}$ ). (This is explained in more detail in [Chapter 4](#).)

## Collecting/Sensing the Particulates

Once the impactor setting is selected, the EVM collects (or measures) real-time aerosol/dust concentration using a 90° optical light scattering photometer to determine the total mass concentration (in units of  $\text{mg} / \text{m}^3$ ) of particulate matter. Additionally, gravimetric sampling, a more accurate method, is also used to determine the mass of particulates.

## Gravimetric Sampling

Gravimetric sampling is a type of filtering process in which the particulates are collected and filtered into the gravimetric cassette after the dust passes through the optical engine of the EVM. A user supplied sealed gravimetric cassette can be used in place of the cassette provided by TSI. The sealed cassette can be sent to a laboratory for analysis. This testing is typically used to measure personal exposure to inhalable dust concentrations.



## Pump

The pump is used in the particulate sampling process as a source of air movement so the particulates are aspirated (or suctioned out) and collected for measurement. The flow rate is 1.67 Liter per minute. The pump is typically calibrated before each gravimetric sampling.

## Gas Sensors Sampling

The EVM uses a unique smart sensor technology includes automatic sensor recognition and measures up to three gases simultaneously: a selection of optional nine toxic gases, Carbon Dioxide, combustible gases, and VOCs.

## Gas Sensors and Path

TSI's unique smart sensor technology includes automatic sensor recognition, calibration levels, temperature compensation information and other valuable data that travels with the sensor from one unit to another.

The following diagram illustrates the gas sensor path for Toxic, CO<sub>2</sub>, and PID sensors. It also identifies the temperature sensor for additional analysis/measurements.

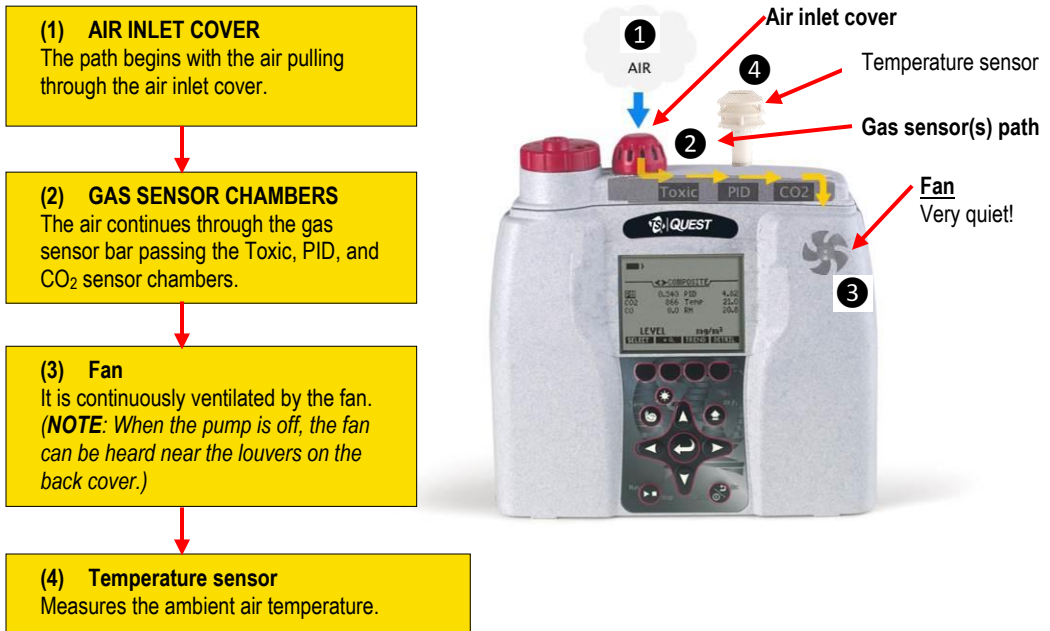

Figure 1-3: Gas sensor path illustration

## Volatile Organic Compounds (VOCs) Sampling

According to the American Lung Association, Volatile Organic Compounds (also referred to as VOCs) are one of the top Indoor Air Quality (IAQ) pollutants. These include:

- Biological agents (mold, dust, mites, etc.)
- Formaldehyde
- Second-hand tobacco smoke
- Volatile organic compounds (measured with a PID detector)

Serious, long-term exposure could lead to health affects including leukemia, cancer, eye and respiratory irritations and short term effects such as dizziness, memory loss, and visual impairments.

With the EVM you have the following parameters:

- Range 0 to 2,000 ppm Isobutylene.
- Calibrated with Sensitivity 1.0, using Isobutylene. Response varies with each VOC.
- Units selection: ppm, ppb, mg/m<sup>3</sup> (for ppm PID sensor) or µg/m<sup>3</sup> (for ppb PID sensor).

## Temperature, Relative Humidity, Dew Point

It is important to monitor temperature, control moisture, relative humidity, and monitor dew point levels in occupied spaces such as office buildings, schools, and hospitals, to name a few. With the presence of too much moisture mixed with dirt/dust particles, this can contaminate the environment and enable mold to thrive. High levels of relative humidity (RH) is a contributor of spreading and growing biological pollutants such as molds, mildew, viruses, mites, building dust, and pollen. Failure to control water leakage from humidifiers, refrigerators, and ventilation equipment can also lead to high levels of RH and high Dew Point. For appropriate air quality control, RH levels should be maintained between 30 to 50 percent in a home/office environment. Some of the common side effects include nausea, headaches, running nose, coughing, and difficulty breathing to name a few.

## What the Standards Say

Many organizations have studied and analyzed the effects of toxic gas and particulate exposures. As a result, standards were developed to regulate exposure. In the United States, the Occupational Safety and Health Administration (OSHA), the Mine and Safety and Health Administration (MSHA), and the American Conference of Governmental Industrial Hygienists (ACGIH), NFPA (National Fire and Protection Agency), National Institute and Technology (NIST), and American Society of Heating, Refrigeration, and Air-Conditioning (ASHRAE) have all created regulations and limitations on total permissible exposure levels.

International standards are specified by the health and safety regulations such as the European Union (EU) and the European Committee of Air Handling and Refrigeration Equipment Manufacturers (EUROVENT-CEDOMAF). For Canadian standards, the Canadian Standards Association (CSA) specifies air quality guidelines/regulations.



## Resources

To access some of these copyrighted standards, refer to the following:

OSHA	<a href="http://www.osha.gov">http://www.osha.gov</a>
NFPA-654	<a href="http://www.nfpa.org">http://www.nfpa.org</a>
MSHA	<a href="http://www.msha.gov">http://www.msha.gov</a>
NIOSH	<a href="http://www.cdc.gov/niosh">http://www.cdc.gov/niosh</a>
ACGIH	<a href="http://www.cdc.gov/niosh">http://www.cdc.gov/niosh</a>
ASHRAE	<a href="http://www.ashrae.org">http://www.ashrae.org</a>
NIST	<a href="http://www.nist.gov">http://www.nist.gov</a>
IEC	<a href="http://www.iec.ch">http://www.iec.ch</a>
CSA	<a href="http://www.csa.ca">http://www.csa.ca</a>

# EVM Series

## Applications

A real-time, direct reading dust monitor is used in many different applications such as walk-through surveys in manufacturing, wood making plants and/or bakery shops, background sampling, site dust measurements, assessment of the effectiveness of dust control systems, and measurement of indoor air quality (IAQ). It is also used to analyze work-place exposure and help identify dust control techniques such as training or implementing engineering controls.

	<p><input checked="" type="checkbox"/> <b>Industrial setting</b> - Used to monitor and ensure health and safety in settings where toxic fumes are released (such as testing levels at a paper mill or a foundry). This information can be used to identify the source and particle concentrations.</p>
	<p><input checked="" type="checkbox"/> <b>Sick Building syndrome</b> – Used to evaluate air toxins and ensure building standards maintain a comfortable work setting.</p>
	<p><input checked="" type="checkbox"/> <b>Work site assessments.</b></p>
	<p><input checked="" type="checkbox"/> <b>Military applications.</b></p>
	<p><input checked="" type="checkbox"/> <b>Outdoor monitoring</b> applications include construction sites/dust outside of mines.</p>
	<p><input checked="" type="checkbox"/> <b>Regulatory compliance</b> (i.e., OSHA, MSHA, IEC, ACGIH).</p>
	<p><input checked="" type="checkbox"/> <b>As a mapping device</b>- Layout a grid of high contaminant areas, and quickly collect sample data at multiple locations to help identify paths and sources, by relative readings.</p>
	<p><input checked="" type="checkbox"/> <b>As a survey monitor</b></p> <ul style="list-style-type: none"> <li>• <b>Specific area in a plant/facility</b> – used to maintain a quality work environment and conduct area monitoring samples throughout an entire facility.</li> <li>• <b>Specific areas in a plant/facility</b>- used to identify key areas that may be toxic or unsafe and implement acceptable <b>practices</b> such as changes in the ventilation.</li> </ul>

## Models Explained

The EVM Series simultaneously measures and data logs specific sensors/parameters that were ordered with your instrument. The models, sensors, and accessories are explained in detail below. Refer to the part's listing for further details (such as calibration accessories).

Models and Sensors	Optional Sensor Accessories
<p><b><u>EVM-7 includes:</u></b></p> <ul style="list-style-type: none"> <li>✓ Particulates</li> <li>✓ Carbon monoxide (CO) or (1) selectable toxic gas               <ul style="list-style-type: none"> <li>• Selectable toxic gas sensors include:                   <ol style="list-style-type: none"> <li>1. Carbon Monoxide (CO) 2. Chlorine (CL2)</li> <li>3. Ethylene Oxide (ETO) 4. Hydrogen Cyanide (HCN)</li> <li>5. Hydrogen Sulfide (H<sub>2</sub>S) 6. Nitric Oxide (NO)</li> <li>7. Nitrogen Dioxide (NO<sub>2</sub>) 8. Oxygen (O<sub>2</sub>)</li> <li>9. Sulphur Dioxide (SO<sub>2</sub>)</li> </ol> </li> </ul> </li> <li>✓ Volatile Organic Compounds with PID ppm or PID ppb sensor               <ul style="list-style-type: none"> <li>• ppm – parts per million (0 – 2,000 ppm)</li> <li>• ppb – parts per billion (0 – 50,000 ppb)</li> </ul> </li> <li>✓ Relative Humidity</li> <li>✓ Temperature</li> <li>✓ Carbon Dioxide (CO<sub>2</sub>)</li> </ul>	<ul style="list-style-type: none"> <li>✓ Air Probe-10</li> </ul>
<p><b><u>EVM-4 includes:</u></b></p> <ul style="list-style-type: none"> <li>✓ Carbon monoxide (CO) or selectable toxic gas</li> <li>✓ Relative Humidity</li> <li>✓ Temperature</li> <li>✓ Carbon Dioxide (CO<sub>2</sub>)</li> </ul>	<ul style="list-style-type: none"> <li>✓ Air Probe-10</li> <li>✓ Toxic sensor/CO sensor</li> <li>✓ CO<sub>2</sub> sensor</li> <li>✓ PID sensor</li> <li>✓ Particulates</li> </ul>
<p><b><u>EVM-3 includes:</u></b></p> <ul style="list-style-type: none"> <li>✓ Particulates</li> <li>✓ Relative Humidity</li> <li>✓ Temperature</li> </ul>	<ul style="list-style-type: none"> <li>✓ Air Probe-10</li> <li>✓ Toxic sensor/CO sensor</li> <li>✓ CO<sub>2</sub> sensor</li> <li>✓ PID sensor</li> </ul>

*(This page intentionally left blank)*



# Getting Started

This chapter is designed to guide you through basic information you will need to begin measuring with your environment monitor.

## Checking the Equipment

If your instrument was sent to you in a storage case, remove all the packaging and acquaint yourself with the following equipment.

**NOTE:** Depending on the accessories you selected, the EVM may have the components displayed in Figure 2-1. For additional sensors or other accessories, refer to [“Replacement parts.”](#)

	<p>Environmental Monitor (EVM)</p>		<p>USB cable- connects to the external output of the EVM to your PC</p>
	<p>DMS software</p>		<p>**Universal Power adapter (External Power supply for EVM)</p>
	<p>Sample sensor (Your sensors will be calibrated and placed inside the instrument, depending on what you ordered. The sensor type is labeled on the side of the cylinder.)</p>		<p>Example of a cal gas and regulator</p>
	<p>HEPA filter/Zero filter for particulate calibrations</p>		<p>PID cleaning kit (for measuring VOCs) (Cotton swabs, cleaning solution, &amp; electrode pellets)</p>
	<p>Silicone grease (for greasing impactors )</p>		

Figure 2-1: Identifying your equipment

## Display and Keypad

The keypad is used to run and stop your studies, view your measurement values, select appropriate set-up parameters, and power on and off.

### Diagram

The following diagram explains the features on the display and keypad.



Figure 2-2: EVM keypad and display explained

### Keypad description

Keypad	Explanation
1. Display	Used to view data, menus, and various indicators.
2. Backlight	Used to illuminate the background of the display screen. (i.e., nighttime study.)
3. Particulate pump	Used for particulate measuring. Toggles the internal pump on and off (used for particulate measurements)
4. Left arrow	Used to toggle through the views and to move left through menu selections.
5. Run/Stop	Used to Run or Stop log session.
6. Indicators	Status information is provided by the instrument at the top of the display.
7. Soft keys	The soft keys are only applicable when a second menu appears above the keys. For example, in the Dust measurement screen, a lookup soft key, a trend menu, and a detail menu appear directly above the soft keys on the display.
8. Up arrow	Used to select menu options (in the setup screens) and select measurement values (or data).

Keypad	Explanation
9. Alt/ key	The Alt/ key (or Alternate Functions) is used to switch between soft key menu and selected menu. This is an option in various screens (ie, calibration screens).
10. Enter key	Used to open a selected menu. Toggles through selected measurement parameters when viewing measurement screens.
11. Right arrow	Used to toggle through the views and to move right through menu selections.
12. Down arrow	Used to select menus options (in the setup screens) and select measurement values (or data).
13. On/Off/Escape	Used to turn on the EVM, turn off, and to Escape (or move back one screen).

Table 2-1: Keypad/user interface explained

## Turning on

- To turn on the EVM, press the **On/Off /Esc** .
  - A TSI splash screen will appear including the firmware version name.
  - Proceeding the splash screen, you will be viewing the **Start** screen.



## Start Screen Explanation

The main screen you encounter and is referenced throughout the manual is the Start screen. From the start screen, you can access the measurement screens, the setup screen, calibration screens, file system screen (used to view past sessions and clear data), and unit information screen (includes serial number information). (The measurement screens are explained in more detail in [Chapter 5](#).)

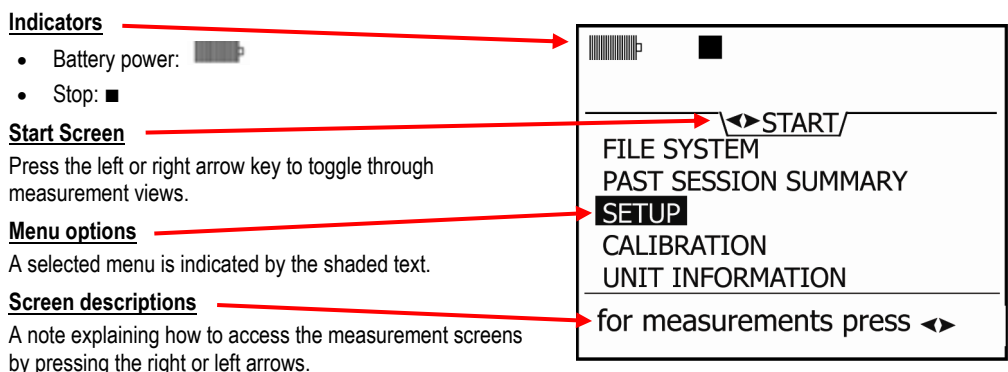
- To select a menu option, press **▲/▼ Arrows** and then press **Enter** . (This will open the selected menu screen.)
- To view the measurement screens, press the **Right or Left Arrow** **◀/▶** and this will toggle you through the measurement views.



**Indicators**

- Battery power: 
- Stop: 

**Start Screen**  
Press the left or right arrow key to toggle through measurement views.

**Menu options**  
A selected menu is indicated by the shaded text.

**Screen descriptions**  
A note explaining how to access the measurement screens by pressing the right or left arrows.

Figure 2-3: Start screen defined

## Navigating

Once the EVM is powered-on, press the **Up/Down Arrow** ▲/▼ key to select a menu or to edit a field.

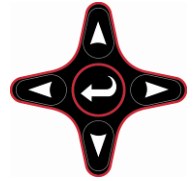

Press the **Left/Right Arrow** ◀/▶ key to scroll through measurement screen, start screen, or to move right or left in a menu (i.e., setup menu).

Press **Enter** ↵ key to open a selected screen (i.e. Setup screen). It is also used to save Setup parameters.

The **On/Off/Esc** ⏻ key also functions as a navigational tool and is used to move back one screen (or escape). It can be used if you are viewing a Setup screen, File System screen Calibration screen or Unit Information screen. At any time, you can cancel a set-up change, file system change (etc...) by pressing the **On/Off/Esc** ⏻ key.

## Indicators/Icons on the display

The EVM is equipped to notify you of operational/status updates. These indicators (or alert notices) are located at the top of the screen. Table 2-2 explains the function of each indicator.

Indicator Icon	Explanation
■	<b>Stop</b> – indicates the instrument is currently in the stop status (opposed to run).
▶	<b>Run</b> - indicates the instrument is currently logging a session/study.
	<b>Battery charge status</b> - This icon shows the remaining capacity of the batteries. A full battery indicates the instrument is fully charged.
	<b>Pause</b> – The pause indicator is shown during the 5 second countdown to prime the airflow prior to entering the run mode when a log session is started.
OL	<b>Overload</b> –will appear whenever the level measurement exceeds the range of the instrument.
⤴	<b>Alt f key (Alternate Function key)</b> - this icon appears below the Battery Charge Indicator when alternate functions are being displayed. (For example this is used in the Trend screen to view the time history on the chart.
UR	<b>UnderRange</b> – will appear whenever a level measurement is below the range of the instrument.
00:00:00	<b>Run Time</b> – displays the current elapsed log session run time. When elapsed time is less than 100 hours, time is displayed as HR:MIN:SEC. When the elapsed time has exceeded 100 hours, time is displayed as HR:MIN where HR uses 4 digits and MIN uses 2 digits.

Table 2-2: Indicators (i.e., run, stop, battery, Alt f)



## Turning Off

When turning off the EVM, ensure you are in stop mode. A stop indicator will appear on the top left next to the battery charge status icon. If it is in run mode, stop the session and then proceed below.



1. From any measurement view or the start screen, press the **On/Off Esc** .
2. “3, 2, and 1” countdown will appear as the EVM is powered off. Continue to press and hold until the instrument is powered off.
  - ☑ **NOTE:** To cancel the shutdown process, release the **On/Off/Esc** key and it will return you to the screen you were previously viewing (i.e., PM measurement screen).
  - ☑ **Auto-Run Note:** If an auto-run session has been set, the auto-run summary screen is displayed prior to turning off. See section, Auto-Run in [Chapter 3](#).

## Instrument Information

The general information screen also called the “unit info” screen is used occasionally to check the type of instrument you purchased and displays the serial number and firmware versions.

### Unit Information Screen

➤ **Opening the unit info screen**

1. Turn on the EVM by pressing the **On/Off/Esc** .
2. In the start screen, press the down arrow repeatedly until **Unit Info** is selected and press **Enter** .

The unit info screen will appear.

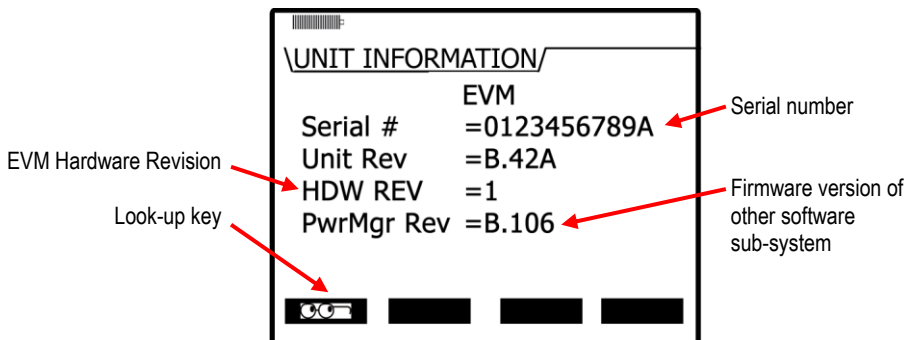



Figure 2-4: Unit Information screen

3. To view the installed sensors, repeatedly press **Enter**  and it will display the Unit Info screen with the installed sensors. (See Figure 2-6).

- Or press the **Look-up** key. Then press the **▲/▼ Arrow** to select and press **Enter** to open the screen. (Repeat this step to view the other sensor.)

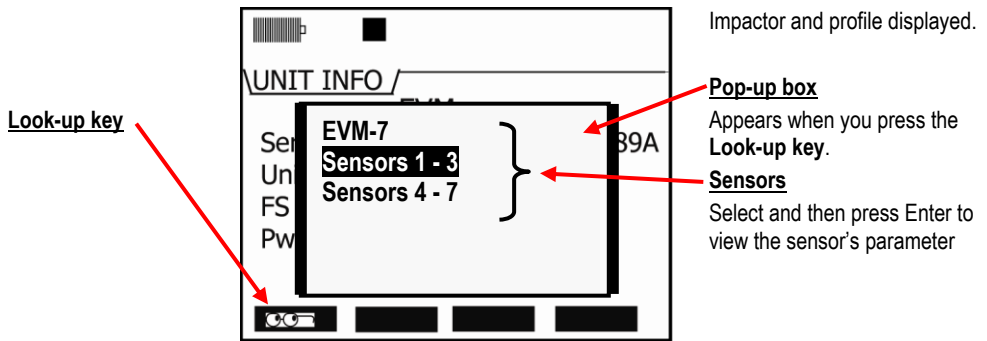

Figure 2-5: Selecting Unit Info. Sensors

- Unit Info screens are displayed below.
  - Screen "A" displays the particulates (PM), temperature (temp), and humidity as "Installed" or "Enabled" sensors.
  - Screen "B" displays CO<sub>2</sub>, CO (or installed toxic sensor), and PID with the associated serial numbers. Air Velocity is listed as "Not Found" which indicates that the sensor was not installed.

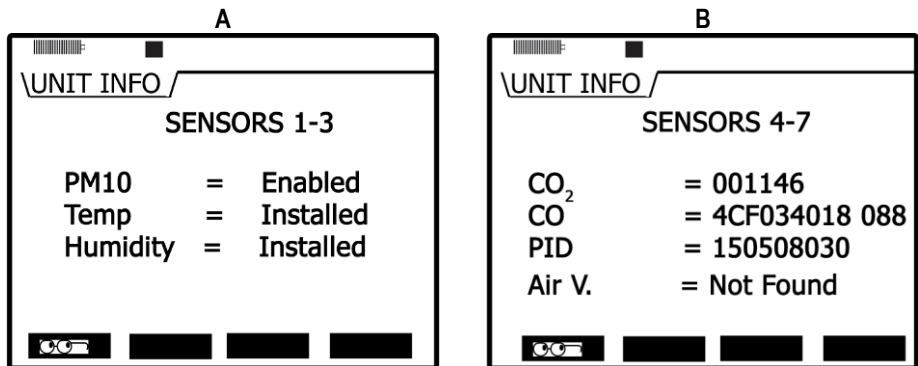

Figure 2-6: Viewing installed sensors

## TSI Detection Management Software DMS

DMS is a software application designed by TSI that runs under the Windows operating system. You can use DMS for a variety of functions such as: customizing your set-up parameters, displaying data, manipulating data, and creating reports.

### Communicating

A USB cable (included in the kit) is used for communicating between the EVM and the software. (First remove the black rubber casing over the ports and then insert the USB cord in the bottom connector.) (See [Chapter 6](#) for more details on software and the EVM.)



Figure 2-7: Communicating with DMS via USB cable

## Powering and Outputs on the EVM

### Battery

The battery is an internal Lithium-ion Rechargeable battery pack. The minimum hours of operating time is 8 hours of continuous operation including setup time, run time, and viewing your result time. This battery is not user accessible or replaceable.

The universal power adapter cord is a 10 to 16 volt power inlet (nominal 12 VDC) with 1.5 amps and is used as an external power source. (For more details on battery power, see “Checking battery power” in [Chapter 3](#)).

## Charging

The rechargeable battery pack is charged by plugging in the universal power adapter cord into the charging-port and into an electrical outlet. When using the EVM and the power adapter, it will charge as you use the instrument. The estimated time to recharge a fully discharged battery pack is approximately five hours. It is important to understand that the USB connection/cable will not charge the internal battery. USB is used for communication purposes only.

☑ **NOTE:** When the batteries are depleted and if you are charging the instrument, the temperature sensor will read at a higher level. Thus, it is recommended to measure the **temperature** when you are **not charging** the instrument.

## About the Environment

If the environment you are in is above 40° C (104° F) when charging the battery then you will be unable to charge the battery. (See [Appendix D](#) for screen warnings.)

## Outputs

The digital output and/or analog output can be used to connect to external devices such as a chart recorder or a light notification device. The monitor's digital out and analog out channel are accessible through the **Input/Output** connector. The air velocity wand also uses this connector. (The following diagram depicts the backside of the instrument without the back cover and the black rubber casing removed.) For more information on connecting and using a stereo plug, see [Appendix D](#).

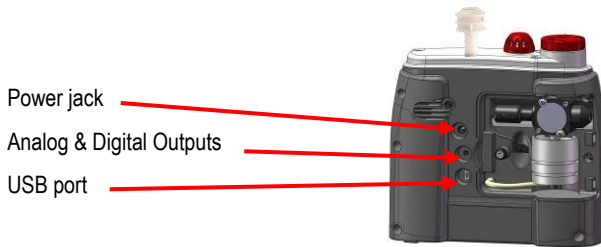

Figure 2-8: USB, power jack and digital output port

# Setting up the Environmental Monitor

The focus of this chapter is to address all of the setup options available on the Environmental Monitor (EVM). Once your parameters are selected, refer to the Calibration chapter (see [Chapter 4](#)).

**NOTE:** If you are using DMS, you may want to program all of your settings via the software. The program allows you to save setups and apply them for future measurements/tests. Refer to [Chapter 6](#), for DMS details.

## Setting up Parameters via the Keypad

The following user-adjustable setup screens are explained will appear for all instrument models:





- Time and date screen
- Battery power check screen
- Logging screen includes selecting the logging interval, averaging time, and logged measurements
- Display settings include: key clicks, language, and display contrast features
- Setting up **Input/Output** (I/O) options including digital-out, air velocity, or analog-out

If you ordered the EVM-7 model, a **Particulate** setup menu and a **PID** setup menu will also appear.

## Time and Date Setting

The EVM uses a 24-hour clock (military time) and specifies date by day, month, and year. The date and time setting are important elements used as you are analyzing your log data results.

### ➤ Changing time and date settings

1. Turn on the EVM by pressing **On/Off/Esc** .
  - The **Start** screen will appear (see Figure 3-2 for details).
2. Ensure **Setup** is highlighted and press **Enter** . (The **Setup** menu will appear.)
3. In the **Time/Date** screen, press the **▲/▼ Arrows** to select **Time** field or **Date** field. (Note the Day field will update automatically based on the selected day from the date field.)
  - NOTE:** It will be highlighted when selected.
4. Press **Enter**  to move to the update fields (2<sup>nd</sup> column).
5. To change the field values, press **▲/▼ Arrows**. To move to the next field, press the **right/ left** arrow key. Repeat this step as necessary.
  - To return to the first column field (Time, Date, or Day), repeatedly press **Enter**  or press **On/Off/Esc**  to cancel session.

6. Continue to repeat steps 3-5 until all changes have been made.

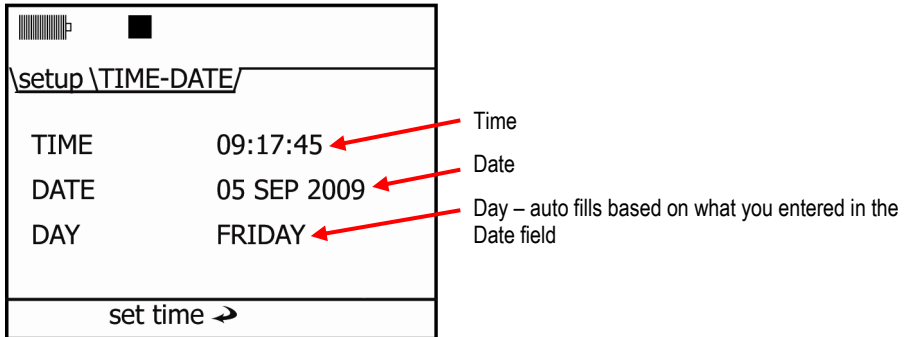



Figure 3-1: Time-Date screen parameters

7. Press the **On/Off/Esc**  twice to return to the start screen.
- \* Remember, once you return to the start screen, you can press the right or left arrows to toggle through the measurement screens.

## Checking Battery Power

The battery power is supplied by an internal lithium-ion rechargeable battery pack with a minimum of 8 hours of continuous operation.

**NOTE:** The battery pack is not-user replaceable and would need to be changed at TSI or your authorized dealer.

The battery screen is used to determine the battery capacity status. When operating from the battery, you can check the remaining capacity of the battery pack at any time by accessing the Battery screen. Additionally, a battery indicator will be present on all screens to notify you of the remaining battery capacity. If the battery indicator is at 100%, it will look similar to the Figure 3-3 below.

If you are charging the battery, the battery screen will display “battery is charging” with an updating indicator bar. The battery power percentage will update accordingly.

➤ **Check battery power**

1. From the start screen, highlight **Setup** (by pressing ▲ /▼ **Arrows**) and press **Enter** .  
 **NOTE:** If viewing a measurement screen, press the right/left arrow until the start screen appears.

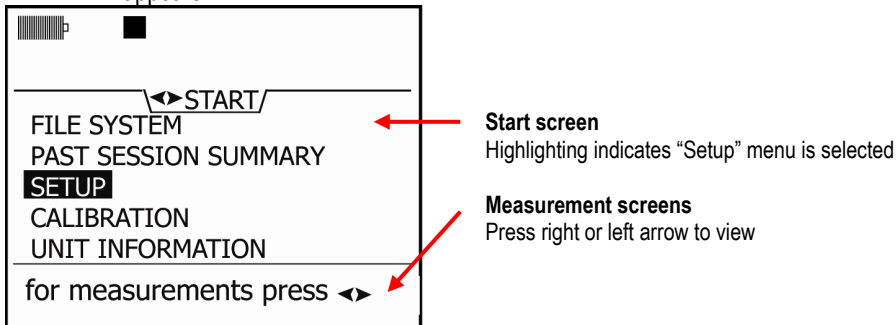



Figure 3-2: Start screen

2. Repeatedly press ▲ /▼ **Arrows** until **Battery** is selected.
3. In the **Battery setup** screen, it will display the remaining capacity on the battery pack.
4. To return to the **Start** screen, press **On/Off/Esc**  twice.

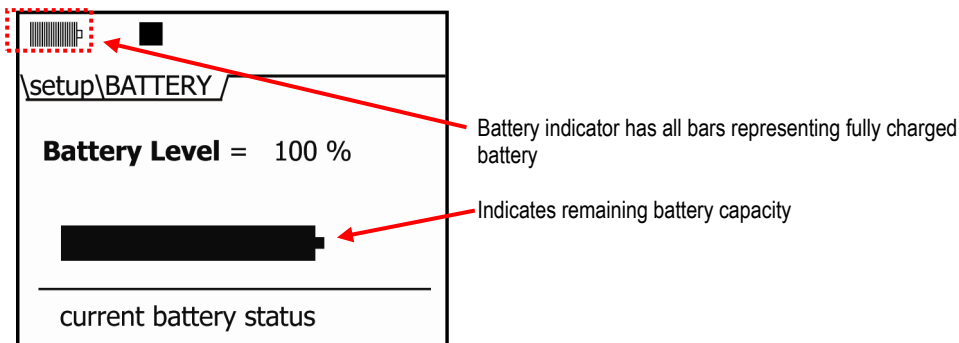

Figure 3-3: Battery screen







## Display: Language, Contrast, and Key Click

In the display screen, there are three selectable settings including language, contrast, and key click.

Display settings	Explanation
Language	With the <b>language</b> setting, there are six options including: English, Spanish, German, French, Italian, and Portuguese.
Contrast	With the <b>contrast</b> setting, you may want to adjust the shading of the display (or screen contrast) by darkening or lightening the screen to fit the environment you will be operating the instrument in. The contrast setting ranges from 1-12 in which 12 represents the darkest and 1 represents the lightest.
Key Click	With the <b>key click</b> setting, you can turn the sound to “on” and each time you press a key on the keypad you will hear a soft click sound. This can be disabled by choosing the “off” setting.

Table 3-1: Display settings explained

### ➤ Changing language, contrast, and key click settings

1. From the start menu, press **▲ /▼ Arrows** to select **Setup** and press **Enter** .
2. Repeatedly press the **▼ Arrow** to select the **Display** menu and press **Enter** .
3. To select a field in the display screen, press **▲ /▼ Arrows** to select one of the fields. Press **Enter**  to move to the 2<sup>nd</sup> column (changeable field).
4. Follow the fields that apply:
  - To change the **Language**, press **▲ /▼ Arrows** to select a specific language. Press **Enter**  to move back to left column or escape to cancel selection.
  - To change the **Contrast**, press **▲ Arrow** repeatedly or press **▼ Arrow** repeatedly to decrease the contrast setting. Press **Enter**  to move back to left column or escape to cancel selection.
  - To change the **Key click sound setting**, press **▲ /▼ Arrows** until **On/Off** is displayed. Press **Enter**  to move back to the left column or escape to cancel selection.

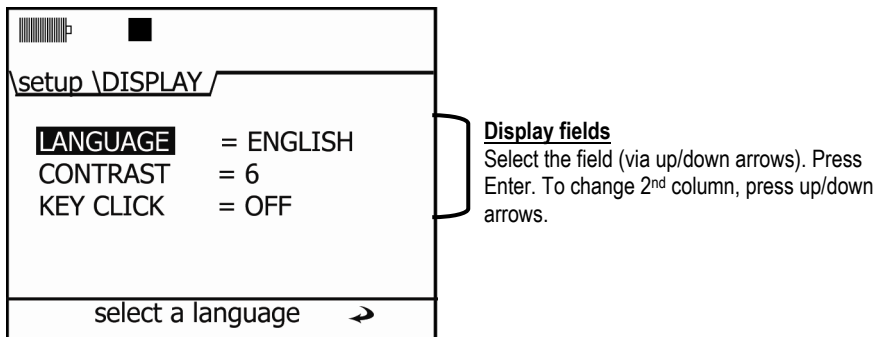



Figure 3-4: Screen display settings



- To return to the **Start screen**, repeatedly press **On/Off/Esc** .

## Setting Logging and Viewing Run Time

With the logging screen, you select the logging interval (i.e., 1 min. data logging), the averaging parameter (i.e., a type of data filter) and which parameters will be logged and stored into memory. An optional field, Run Time, allows you to view the amount of remaining log time when logged parameters are selected.

For logging, there are two selectable fields- the logging interval rate and the measurement averaging.

Log intervals	Explanation
<b>Log interval</b>	This sets the log interval between specific data points. For example, if logging is set to 5 second intervals, then all parameter values are logged every 5 seconds. The logging parameters options are as follows: 1 second, 5 seconds, 15 seconds, 30 seconds, 1 minute, 5 minutes, 10 minutes, 15 minutes, and 30 minutes, and 60 minutes.
<b>Averaging</b>	The <b>Averaging</b> parameter is used to average all measurements displayed on the screen. If averaging is set to 15 then the last 15 measurements are averaged. (New measurements are updated every second.) This averaged value is displayed on the monitor. It's basically a data filter. The averaged data will change less rapidly than the 1 second data since it is averaged. The user options are 1 – 30 with increments by 1 interval.  <b>☑ NOTE:</b> 15 second averaging is recommended for the average setting. All the sensors have settling times of 10 seconds or longer.
<b>Measurements</b>	Selectable logged measurements: Level, Lmin, Lmax, Lavg, and STEL.  If the measurement is set to “ <b>On</b> ”, this indicates the instrument will log data at the logged interval (i.e., while in run mode). “ <b>Off</b> ” indicates the measurement will not log when in run mode.  The measurements include the following: Level (instantaneous or averaged measurement), STEL (short term exposure level calculated over last 15 minutes), Lmax (maximum measurement during log interval), Lmin (minimum measurement during log interval), Lavg (average measurement during log interval), and TWA (time weighted average measurement during interval).  <b>☑ NOTE:</b> See “Table 5-3” for more information.
<b>Run Time</b>	Depending on the logged parameters that are turned “On” for data log and the log interval, the <b>Estimated Run Time</b> screen will display the total remaining run time. For example, if you want to log all parameters the overall run time will decrease significantly. If you would like to extend the run time to a longer duration, logging one or two parameters would be advisable.

**Table 3-2: Logged intervals and selecting logged measurements**

➤ **Set logging intervals, logging attributes, and view run time**

1. From the start menu, press ▲/▼ Arrows to select Setup and press **Enter** . Select **Logging** and press **Enter** .
2. To change Logging Interval or Averaging follow below:
  - Press ▲/▼ **Arrows** to select Logging interval or Averaging.
  - Press **Enter** to move to the changeable field, and then press ▲/▼ Arrows.
  - Press **Enter** to return to the 1<sup>st</sup> column and save your settings.
3. To enable/disable logging, follow below:
  - Select a measurement by pressing ▲/▼ **Arrows**.
  - Once selected, press **Enter** (this will move your cursor to the “On/Off” field.)
  - Press ▲/▼ **Arrows** to toggle and select **On** or **Off**.
  - Press **Enter** again to return to the measurement.
  - Repeat step 3 until all logging parameters are enabled/disabled.

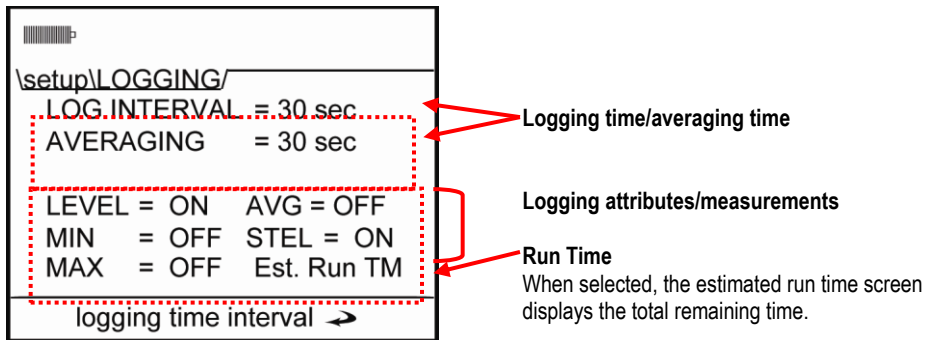



Figure 3-5: Logging screen

4. *Optional:* To view the Estimated Run Time, select this field (by pressing ▲/▼ **Arrows**) and press **Enter** . The estimated run time screen will appear.  
 **NOTE:** To extend the logging time, turn a logged measurement(s) to “Off” and/or change the log interval. Then, re-check the estimated run time.

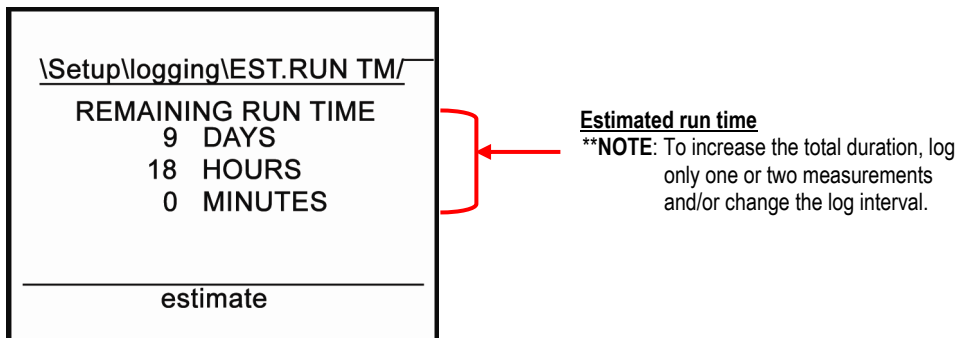

Figure 3-6: Estimated run time for logging screen

5. Press **On/Off/Esc**  repeatedly to return to the Start screen.

## PID Sensor Setup

For best PID testing results, it is recommended to add a correction factor to the relevant VOC you intend to measure. Refer to the PID correction factors table in [Appendix C](#) for more details.

Additionally, the PID setup screen is used to set the ppb zero cal to either enabled or disabled (if applicable).

➤ **Setting PID correction factor and/or ppb zero cal**

1. From the start menu, press ▲/▼ Arrows to select Setup and press Enter ↵.
2. Select PID by pressing ▲/▼ Arrows and press Enter ↵.
3. In the PID screen, select either ppb zero cal or the PID factor by pressing ▲/▼ Arrows.
4. Press Enter ↵ to move to either the disabled/enabled field or the value field. Press ▲/▼ Arrows to change the value. Press Enter ↵ to save your changes.
5. Press On/Off/Esc ⏻ repeatedly to return to the start screen.

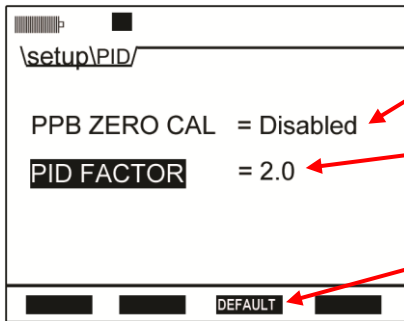

**PPB Zero Cal**

Press up/down arrows to select either enabled/disabled. Press Enter to save.

**PID Factor**

Press up/down arrows on keypad to change value. Press Enter to save.

**Default soft key**

Press to restore PID factor to default ("1").

**Figure 3-7: PID correction factor/ppb setup**

- ☑ **NOTE:** When changing PID factor to a value excluding "1", the PID correction factor will appear as a subscript on the measurement screens. Two samples are displayed below:

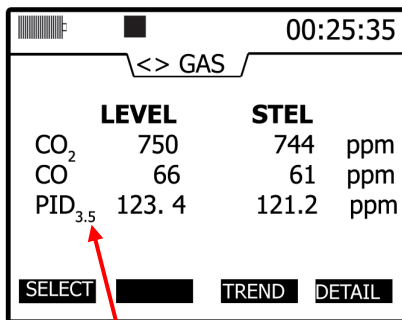

**PID and correction factor**

The applied correction factor "3.5" is displayed in the Gas measurement screen.

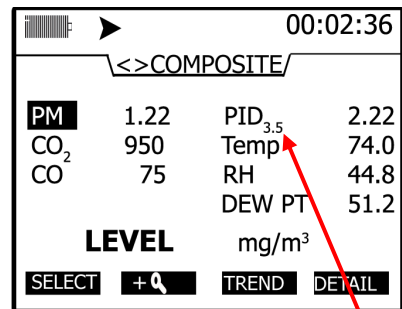

**PID and correction factor**

Displayed in the Composite measurement screen.

**Figure 3-8: PID correction factor displayed on measurement screens**





## Changing Units (Temperature, Particulates, PID, and Air Velocity)

In the units screen, the temperature, particulates, and the air velocity values can be displayed in different measurement units.

- Temperature's setting is either Celsius (°C) or Fahrenheit (°F) with °C as the default.
- Particulates setting is either in mg/m<sup>3</sup> (milligrams per cubic meter) or µg/m<sup>3</sup> (micrograms per cubic meter).
- PID PPM/PPB sensor (VOCs) setting is either PPM or mg/m<sup>3</sup>. PPB or µg/m<sup>3</sup>.
- Air velocity setting is in meters per second or feet per minute.

**NOTE:** If you do not have an air velocity sensor connected, it will not be displayed in this screen.

### ➤ Changing temperature, particulates and/or air velocity units

1. From the **Start** screen (see Figure 3-2 for details), select **Setup** and press **Enter** .
2. In the Units screen, press **▲/▼ Arrows** to select the **Temperature**, **PM** (Particulates), or **Air Velocity** field.
3. Once selected, press **Enter**  to select the units field.
4. Press **▲/▼ Arrows** to select the appropriate unit.
5. Press **Enter**  to save and move back to the first column.
6. To return to the start screen, press **On/Off/Esc**  twice to return to the screen.

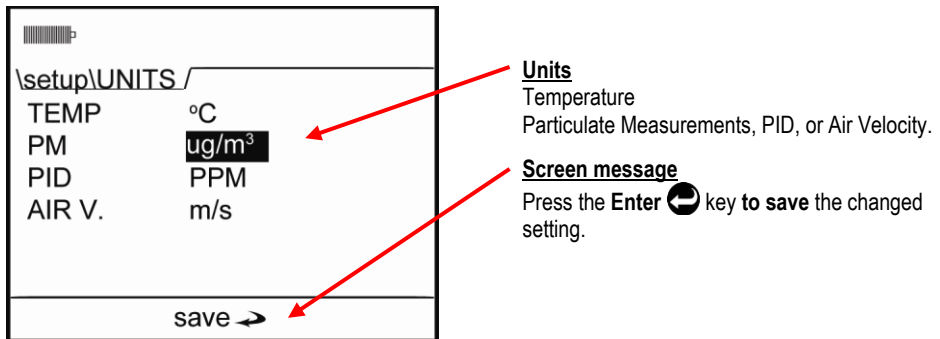

Figure 3-9: Units screen

## Setting up Particulate Settings

There are four parameters in the particulate screen which include:

- **Particulate field**- enables and disables when measuring particulates. (If disabled, it will not enable the pump during run mode.)
- **Profile field** – used to select the active particulate profile. The active profile can be edited by pressing the edit quick key.
- **Gravimetric Mass and Gravimetric volume fields** – displays the accumulated theoretical particulate mass and air volume which has passed through the gravimetric filter (since the last gravimetric reset). These can be reset by pressing the reset quick key.

## Setting Profiles (Particulate Correction Factors)

The EVM supports eight different particulate matter (PM) profiles with customized name settings and user correction factor settings. When the profile field is selected from the particulate menu, you are able to edit this field by pressing the Edit soft key. Once opened, you can change the profile name and correction factor setting. (**NOTE:** Each profile stores up to four calibration verifies.)

1. **Profile Name:** You can change profile name and assign up to eight characters.
2. **Factors:** A user will have different correction factors based on the type of dust you are measuring.

## How Particulate Factors are Adjusted and Calculated

All particulate profiles are factors are calibrated to Arizona Road Dust (ARD) with its particle size and composition. Other dust compositions can be measured accurately by adjusting a profile's correction factor.

- NOTE:** For best measurement results, it is recommended to enter in the dust correction factor prior to your particulate study. (This may require a gravimetric sampling.)



To calculate a **correction factor**, follow the guidelines below:

1. Run the instrument in the applicable environment for a set period of time/volume (i.e., 6–8 hours).
  - **Accumulators:**
    - ✓ The **gravimetric mass accumulator** will display the amount of dust accumulated based on the active profile.
    - ✓ The **gravimetric volume accumulator** will display the amount of volume passed through the gravimetric filter.
2. After the run, check the gravimetric mass accumulator, compare to what was actually measured from the lab, and enter in a correction factor.
  - ★ For example, before measuring ensure the gravimetric accumulators are reset and the gravimetric filter is replaced. Next, you measure for four hours and the gravimetric accumulator is displayed as 10 mg. Then, you measure the dust in the gravimetric filter (or cassettes) and determine the actual weight. If the actual weight is 20 mg, you would change the correction factor from 1 to 2.

## Dust Correction Factors (Profiles)

When setting up the particulate parameters, it is good to keep in mind that the user defined profiles (or correction factors) are a submenu of the particulate menu. Because of this layout, the following section explains how to change the profiles/correction factors and apply a new profile.

### ➤ Setting dust correction factors (profiles)

1. From the **Start** screen, select the **Setup** menu by pressing **▲/▼ Arrows** and press **Enter** .
2. Press **▲/▼ Arrows** repeatedly until **Particulate** is selected and press **Enter** . (The particulate setup screen will appear.)
3. Ensure **Particulate** is set to **Enabled**. (If not, press **▲/▼ Arrows** to enable and press **Enter**  to return to the first column.)

4. Select the **Profile field** by pressing **▲/▼ Arrows** and press the **Edit** soft key.

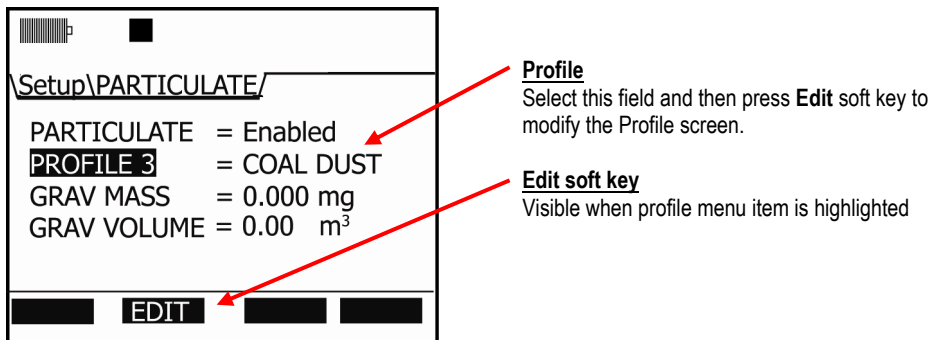

Figure 3-10: Edit profiles for dust calibration

5. Press the **Edit** soft key and the **Edit Profile** screen will open.

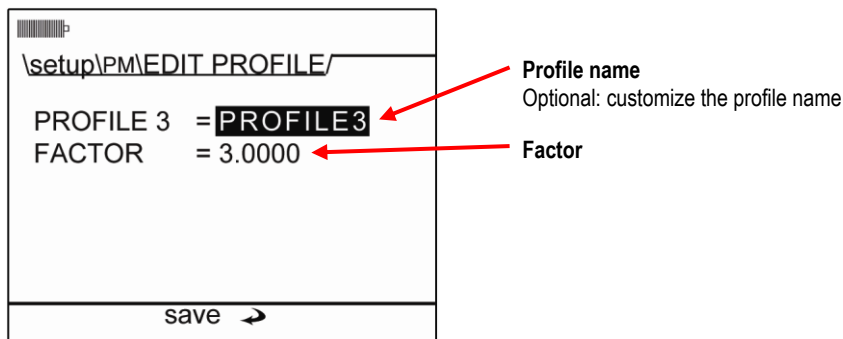







Figure 3-11: Entering a profile for particulate calibration

6. (Optional, see step seven if not changing profile name.) To change the name of the profile, ensure the profile field is selected and press the **Enter** (↵). Press **▲/▼ Arrows** to change the characters. To move to the next position, press **◀/▶ Arrows** then press **Enter** (↵).
7. Press **▼ Arrow** to select the **Factor** and press **Enter** (↵) to move to the 2<sup>nd</sup> column. Press **▲/▼ Arrows** to change the numeric value. Press the left/right arrow key to move to the next position. Continue this process until the appropriate number is selected and press **Enter** (↵) to confirm or **Esc** key to cancel changes.
8. Press the **On/Off/Esc** (⏻) to return to the particulate screen.
9. To apply a new profile, select the profile field and move to the second column (by pressing **Enter** (↵).) Then continuously press **▲/▼ Arrows** until the appropriate profile/correction factor is selected. Press **Enter** (↵) to return to the first column.
10. Press **On/Off/Esc** (⏻) twice to return to the start screen.

## Particulate Pump: Enable or Disable

You may want to disable the particulate pump for situations in which the environment is too dirty for the particulate optical engine or if you want to keep the engine and pump clean and dry from oily mists, liquids, or fogs elements. Additionally, you may want to log other parameters, such as CO<sub>2</sub>, Toxic, and/or temperature and humidity parameters and exclude the particulate measurements from a log session. This is changeable in the particulate screen.



### ➤ Enable/Disable the pump

1. From the **Start** screen, select the **Setup** menu by pressing **▲/▼ Arrows** and press **Enter** .
2. Press **▲/▼ Arrows** repeatedly until **Particulate** is selected and press **Enter** . (The particulate setup screen will appear.)
3. To enable/disable the particulate setting/pump, ensure **Particulate** is selected and press **Enter** .
4. Press **▲/▼ Arrows** to select either Enabled or Disabled and press **Enter** . (Refer to Figure 3-7 to view a sample screen.)
5. Press **On/Off/Esc**  twice to return to the start screen.

## Resetting the Gravimetric Filter

The Gravimetric accumulators display the calculated accumulated mass of particles and the accumulated volume through the gravimetric filter (since the last time these accumulators were reset). At the same time, the particles are actually collected in the gravimetric cassette in the back of the unit. Typically the gravimetric accumulators are reset when the gravimetric cassette is replaced by the user.

### ➤ Resetting gravimetric filter

1. From the Start screen (see Figure 3-2 for details), select Setup by using **▲/▼ Arrows**. Press **Enter** .
2. Press **▲/▼ Arrows** to select the Particulate screen and press **Enter** . (The particulate screen will appear.)
3. To reset the Gravimetric filter, select the Grav. Mass/Grav. Volume fields by pressing **▲/▼ Arrows**. Once selected, the Reset soft key will appear. Press this soft key to reset.

#### Reset soft key

Visible when grav. mass menu item is highlighted

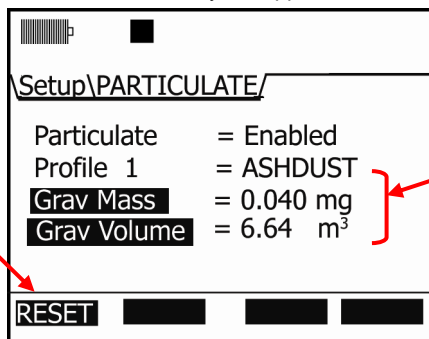

Displays accumulated particulate mass & volume

Figure 3-12: Particulate setup screen



- To return to the main menu, press **On/Off/Esc**  twice.

## Auxiliary Input/Output

### Digital Output

With the digital output function, the user can connect an external device to the monitor. This can be used to signal a specific level to turn on a notification device, an LED, or a fan motor at a specific threshold (or set point). Once enabled, the following three are selectable parameters: a sensor, logic setting, and threshold setting.

#### Sensors

When setting the Digital Output (“Digital-Out”) parameters, one of the seven selectable sensors is used to trigger the output of the external device which includes:

- RH (relative humidity), CO<sub>2</sub> (Carbon Dioxide), Temp (Temperature), PM (particulate matter), PID (for measuring VOCs), Toxic gas (i.e. CO), and Dew Point.

**NOTE:** Air Velocity cannot be selected as a sensor.

#### Logic and Threshold

There are four selectable “Logic” types which is used in combination with the Threshold field to trigger on and off the external device. These are explained in the table below.



**NOTE:** The digital output is an open collector output and as such requires the user to install a pull-up resistor.

Digital Out/Logic	Explanation
Active High Pulse	The output will assert an active high pulse for approximately 50 msec when the threshold is exceeded.
Active Low Pulse	The output will assert an active low pulse for approximately 50 msec when the threshold is exceeded.
Active High	The output will be at a logical high level when the threshold is exceeded.
Active Low	The output will be at a logical low level when the threshold is exceeded.
Threshold	Enter in a value to trigger the external device to turn on or off.

**Table 3-3: Digital out/Logic settings**

**NOTE:** The system maintains a hysteresis window around the threshold to prevent output chattering.

#### ➤ Setting or changing digital output

- From the Start screen, select **Setup** menu and press **Enter** .
- Press **▼ Arrow** repeatedly until **Aux I/O** and press **Enter** .
- Select **Digital Out** and press **Enter** .

4. In the **Digital-Out** screen do one of the following:
  - **Dig-Out field:** select via ▲ /▼ Arrows and press Enter ↵. Press ▲ /▼ Arrows to Enable/Disable.
  - **Sensor field:** select via ▲ /▼ Arrows and press Enter ↵. Press ▲ /▼ Arrows to select one of the sensors.
  - **Logic field:** select via ▲ /▼ Arrows and press Enter ↵. Press ▲ /▼ Arrows to select one of the triggering modes.
  - **Threshold field:** select via ▲ /▼ Arrows and press Enter ↵. Press ▲ /▼ Arrows to select a value.
5. To return to the Start screen, press the On/Off/Esc ⏻ twice.

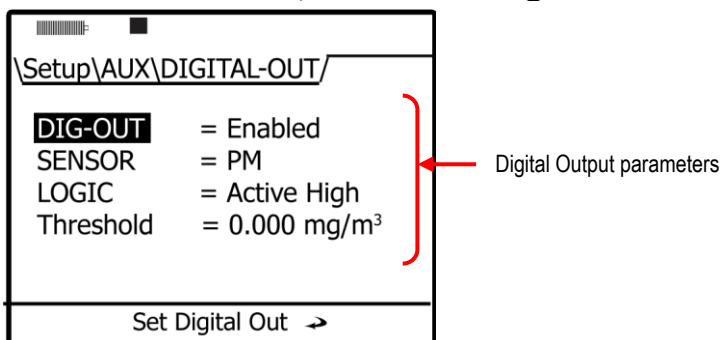





Figure 3-13: Configuring digital output

## Air Velocity

Setting the air velocity parameter is fairly simplistic; however, ensure no other outputs are enabled prior to setup. (The EVM will display a pop-up message if more than one output is enabled. You will have to disable all other auxiliary outputs before proceeding with air velocity setting.) When air velocity is “enabled”, you can measure/log with the TSI Air Probe10 (optional accessory).

### ➤ Setting air velocity

1. From the setup screen, select **Aux I/O** and press **Enter** .
2. Press **▲/▼ Arrows** to select **Air Velocity** and press **Enter** . To change the setting from either enabled or disabled, press **Enter** .

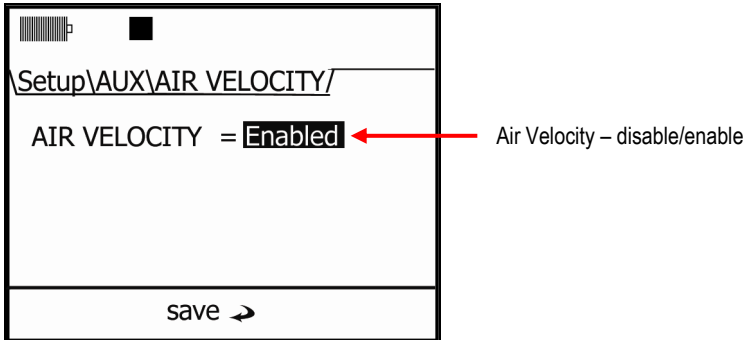



Figure 3-14: Air Velocity setting

3. Press **▲/▼ Arrows** to change the setting.  
 **NOTE:** If you have either the digital-out or analog-out setting enabled, a pop-up message will appear explaining to change the other settings before enabling air velocity.
4. Press **On/Off/Esc**  twice to return to the start screen.

## Analog-out

The analog-out channel provides a voltage reading that is proportional to the sensors output. The analog-out channel can be configured to track any installed sensor. The example displayed in Figure 3-12 shows the results of measuring with the thermometer from 0 to 60°C reading from 0 to 5 volts.

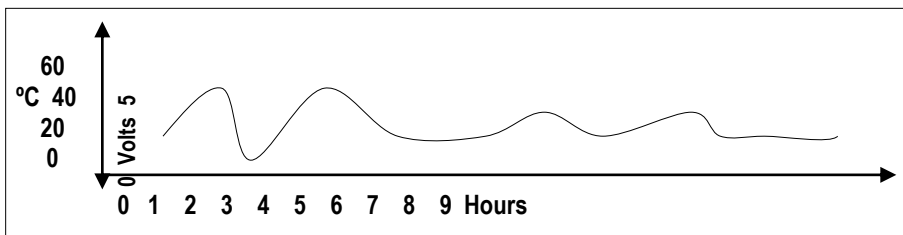

Figure 3-15: Analog out results with temperature as output

➤ **Setting Analog-Out**

1. From the setup screen, select **Aux I/O** and press **Enter** (↵).
2. Press **▲ / ▼ Arrows** to select **Analog-Out** and press **Enter** (↵).
3. To enable or disable, press **Enter** (↵) when **Analog-out** is selected and press **▲ / ▼ Arrows** to change the setting. Press **Enter** (↵) to move back to the 1<sup>st</sup> column.
4. To select a sensor, ensure **Sensor** is selected and press **Enter** (↵). Then, press **▲ / ▼ Arrows** to page through the selection list. Once the appropriate sensor is selected, press **Enter** (↵).
5. To return to the start screen, press **On/Off/Esc** (⏪) twice.

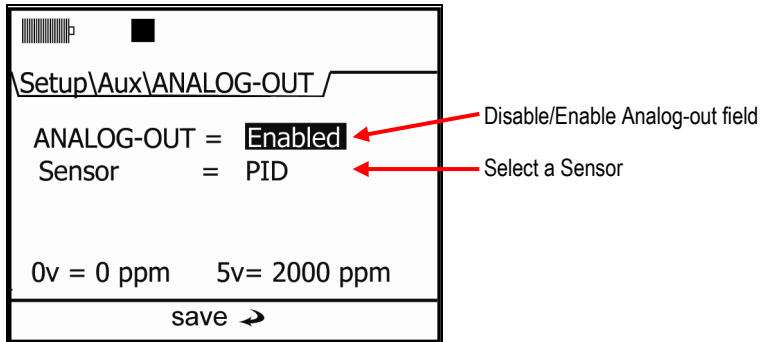

Figure 3-16: Analog-Out screen

## Restoring Default Factory Settings

The EVM is equipped to restore all factory settings and factory calibration settings via the Defaults screen.

☑ **NOTE:** Dew Point and Air Velocity are not user calibrated and therefore, not listed in the restore factory calibration screen.

1. In the Setup menu, press **▲ / ▼ Arrows** until **Defaults** is selected (or highlighted).
2. Press **Enter** (↵) (to open the screen).

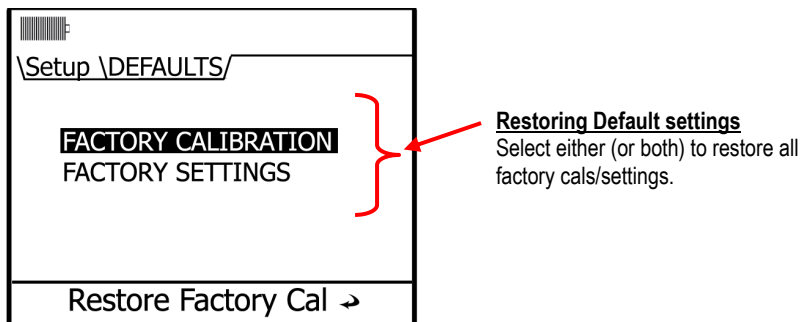



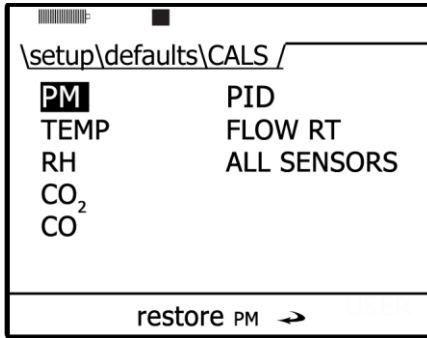



Figure 3-17: Defaults screen (restoring factory settings)

3. To restore the **Factory Calibration**, ensure this is selected and press **Enter** 
  - To restore defaults for a **selected sensor(s)**, select a sensor using **▲/▼ Arrows** and press **Enter** . In the pop-up screen, select “**Yes**” via the **Left Arrow** (or **No** to cancel) and press **Enter** .
    - ✓ Repeat as necessary to restore each selected sensor.
  - To restore all sensors, select **All Sensors** (via up/down arrows) and select **Yes** in the pop-up screen (or **No** to cancel). Press **Enter** .



**Restoring Default Cals**  
Select a sensor, Choose **Yes** or **No** with the screen prompt and press **Enter** key.

Figure 3-18: Restoring default calibrations

4. To restore the **Factory Settings**, press **▲/▼ Arrows** to select and press **Enter** 
  - A **Restore Factory Settings** pop-up screen will appear. Press either **Yes** or **No** (with **◀/▶ Arrows** and **Enter**  to confirm).

## Backlight Setting

A key on the keypad is dedicated to turning on or off the backlight feature. When turned on, the backlight will illuminate the screen from a dark gray to a light gray color. This feature has two levels of brightness.

When turning on, click the backlight key once for a lighter backlight. Press a second time for a darker contrast.

To turn off, repeatedly press the backlight key until it is turned off.



**Backlight**  **key**  
Press to turn on. This feature has three levels (off, dim, bright).

Figure 3-19: Backlight key

## Resetting the EVM

At times, you may need to reset the instrument if it is unresponsive.

1. To manually reset, press and hold **On/Off/Esc**  for about 8–10 seconds and the instrument will power off.

## Lock/Secure Run and/or Setup

The lock or security feature is designed to lock the EVM during a run to ensure the session will not be stopped unless the lock feature is disabled. Likewise, this feature includes a locked (or secure) setup mode which will stop you from editing a set-up. Once one or both of these options are programmed with a code, it is set by pressing the Lock soft key in the Setup menu.

**NOTE:** When securing or locking the instrument, it will be in lock mode even when powered off/on.

➤ **Setting lock setup or run**

1. From the **Start** screen, select and open the **Setup** screen.
2. Press the **Lock** soft key.

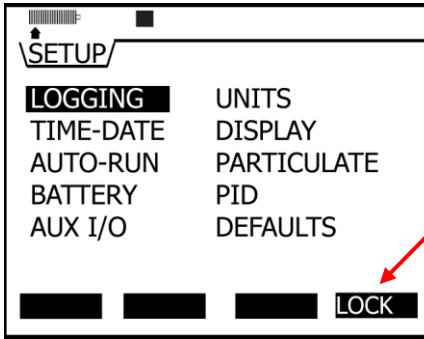

Lock  
 Opens to the Lock screen.

Figure 3-20: Lock Soft key

3. In the **Lock/Security Modes** screen, **Run** and **Setup** are “disabled” as the default setting.
4. To enable either one, first select **Run** or **Setup** fields (by using **Up/Down Arrows**).
5. Press **Enter**  and the first field will be shaded/selected, and then press **▲/▼ Arrows** to change the numeric value.

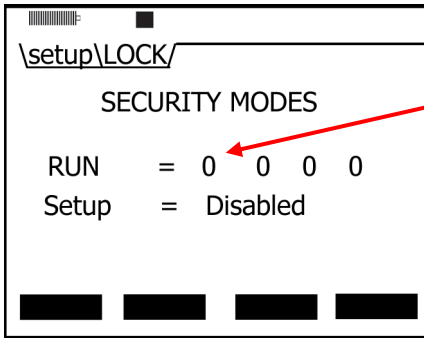

Adding a numeric password

- Press **Up/Down** arrows to enter a number.
- Press **Left/Right** arrow keys to move to the next field.
- Repeat as necessary.

Figure 3-21: Setting lock/secure

6. Repeat step 5 until the password is entered. When you press **Enter**  for the fourth digit, a secure run mode or secure setup pop-up will appear as confirmation. Once set, the field will display “Enabled”.
7. Once enabled, follow one of the scenarios below:
  - For **Secure** run mode to occur, navigate to one of the measurement screens and press the Run key. A “Secure Run Mode” screen will appear.
  - For **Secure** setup mode to occur, navigate to the setup screen and the “Secure setup mode” screen will appear.

## Unlock run and/or setup

When in secure run mode or secure setup mode, a quick press of the lock/unlock soft key and entering in the password will unlock the instrument. (See steps 5 and 6 above to for more information on entering in the password.)

- ☑ **NOTE:** If the entered password to unlock the instrument was forgotten, a default TSI password can be used in lieu of the entered password, “9157”.

## Auto-run

The EVM has four programmable auto-run settings including a timed-run, a date, a day of week (DOW), and a disabled mode.

The EVM is shipped with the auto-run set to the disabled mode. Each mode has more than one setting and is denoted by the “+” (plus) or “-” (minus) soft key symbols. When an alarm is activated (or programmed), a “+” (plus) sign appears. The default alarm mode is set to an off mode and is denoted via a minus symbol (i.e., “-”).

### Auto-run and timed-run mode

With timed-run, you manually start the run (via the run key), and it will automatically stop based on the programmed duration.

#### ➤ Setting auto-run with timed-run mode

1. From the **Start** screen, select and open the **Setup** screen.
2. Select **Auto-Run** by pressing **▲/▼ Arrows** and press **Enter** .
3. In the **Auto-Run** screen, press enter to select **Timed-Run**. If it is not displayed, press **▲/▼ Arrows** repeatedly until selected.
4. Next, press the **-ONE** soft key or select **View/Set Parameters**.

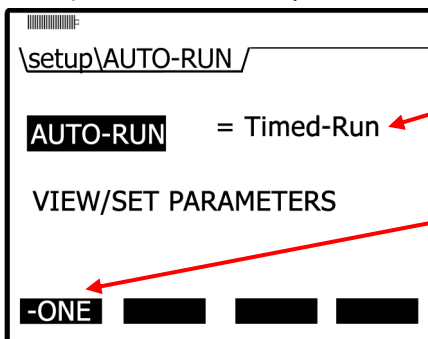

#### Auto-Run and Timed Run setting

- Select **Timed-run** by pressing Enter and then press Up/Down arrows to move through the menu.

#### Timed Run soft key

- Select first soft key to access the Timed run screen

Figure 3-22: Selecting auto-run with timed-run mode



- In the timed-run screen, press **Enter** (↵) to select the duration field which is displayed in hours, minutes, and seconds. To change the duration, press **▲/▼ Arrows**. To move between the fields, press **◀/▶ Arrows**. (Repeat as necessary).

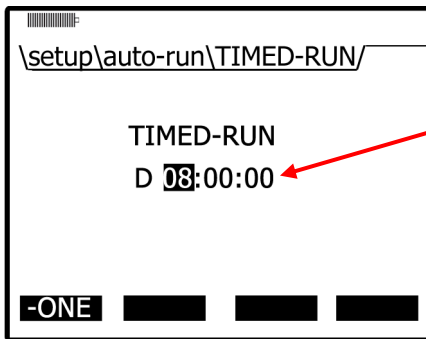

**Duration**

- Select the hours/minutes/seconds with up/down arrows and press **Enter** to move to the next field.

Figure 3-23: Setting timed-run and duration

- Press **Enter** (↵) to save your settings.
  - NOTE:** To begin the Timed-run, press the run/stop key and the instrument will automatically stop at the programmed duration.

**Auto-Run with Date Mode**

With the date mode, it will wake up the instrument from a powered down or on condition, runs the study, saves it, then powers down again. Up to four date settings are programmable with a specified date, time (in hours, minutes, seconds), and duration via the soft keys.

➤ **Setting auto-run with date mode**

- From the **Start** screen, select and open the **Setup** screen.
- Select **Auto-Run** by pressing **▲/▼ Arrows** and press **Enter** (↵).
- Press **Enter** (↵) to select the 2nd column (value field) and press **▲/▼ Arrows** repeatedly until **Date** appears.
- Next, press one of the soft keys. (This will open a Date/Auto-Run screen.)

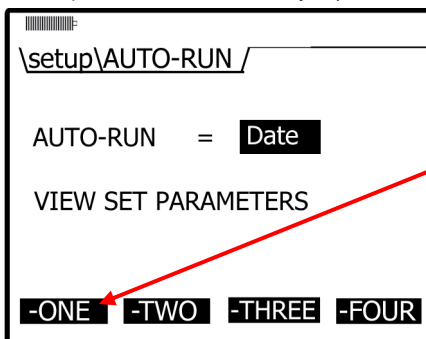

**Soft keys**

- Select a soft key to setup the Date Auto-Run parameters
- Once set, “-one” will appear as “+one” which is turned on.

Figure 3-24: Selecting auto-run with date mode

5. If off appears under **Auto-Run**, press **Enter** (↵) (or skip and see step 6).
6. To change the fields press **▲/▼ Arrows**. To move to the next field(s) press **◀/▶ Arrows**. Repeat as necessary.

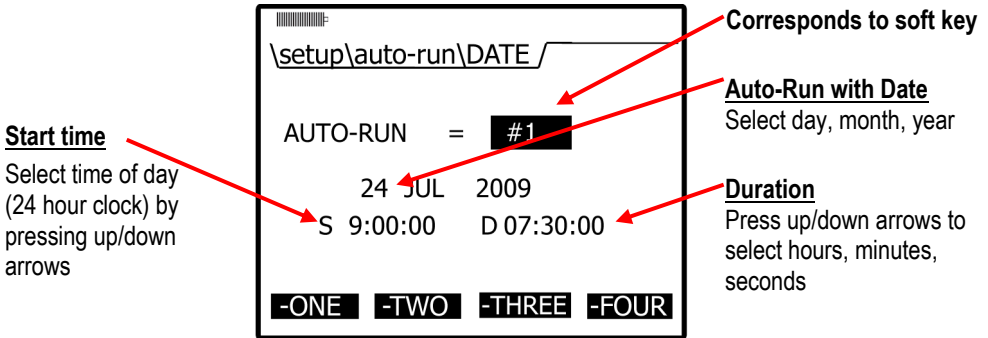

Figure 3-25: Setting auto-run date mode

7. To save, press **Enter** (↵) key. Press (⏪) key until you return to the start screen.  
 **NOTE:** To initiate the programmed run, either power down the instrument or leave on.

### Auto-Run with Day of Week (DOW) Mode

The days of the week (DOW) setting is a pre-programmed weekly auto-run with a specified day, start time, and duration with two auto on settings. The programmable settings include a day of the week, start time, and duration.

#### ➤ Setting auto-run with day of week mode

1. From the **Start** screen, select and open the **Setup** screen.
2. Select **Auto-Run** by pressing **▲/▼ Arrows** and press **Enter** (↵).
3. In the **Auto-Run** screen, press **Enter** and press **▲/▼ Arrows** repeatedly until DOW appears.
4. Press one of the soft keys (one or two).
5. In the DOW **Auto-Run** screen, press **◀/▶ Arrows** to move through the Days, Time and Duration fields. Press **▲/▼ Arrows** to change the value.

6. When programmed, press **Enter** . Press  key repeatedly to return to the main screen.

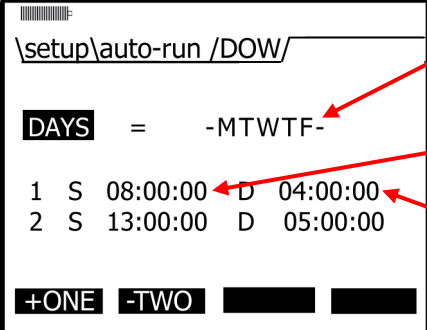

**Days**  
Optional Programming is set from Sunday through Saturday. Example displays Monday through Friday

**S (hours:mins:secs)**  
Start time is programmed at 8 am

**D (hours:mins:secs)**  
Duration is programmed for 4 hours

Figure 3-26: Setting auto-run DOW mode

- NOTE:** To initiate the programmed run, either power down the instrument or leave on.

*(This page intentionally left blank)*

# Calibrate Sensors

## Placement and Calibration of Sensors

Before you begin your measurement sampling, it is recommended to calibrate the sensors you will be using. This chapter focuses on inserting and removing sensors, calibrating each sensor, viewing past calibrations, and how to verify your calibration set points. (Reference the following sections which apply to your installed sensor components.)

### Calibrating sensors include:

- Particulate sensor
- Pump flow rate calibration
- CO<sub>2</sub> and O<sub>2</sub> sensor
- Toxic sensors
- Photo-Ionization Detector (PID) sensor (for VOCs)
- Temperature (temp) and Relative humidity (RH) sensors

### Inserting and Removing Sensors

1. The sensors you purchased with your EVM will be inserted, factory calibrated, and ready for usage. To understand how to insert or replace a sensor this is discussed in the procedures below.  
 **NOTE:** To order new sensors when expired, see [Appendix A](#), Replacement and optional parts.)

#### ➤ Inserting sensors

2. Ensure the instrument is turned off and the external power cord is disconnected. Next, remove the sensor bar by unscrewing two screws from the top compartment with a screw driver.
3. Lift the cover off and set aside. (The location of the sensors is indicated in Figure 4-2.)
4. Remove the black manifold casing.

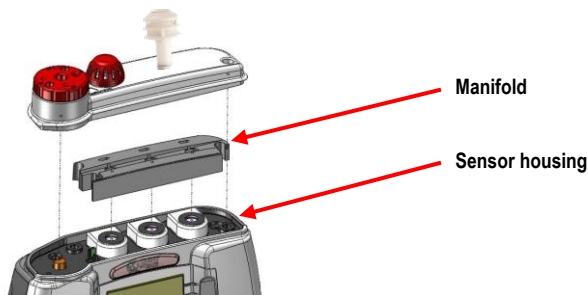
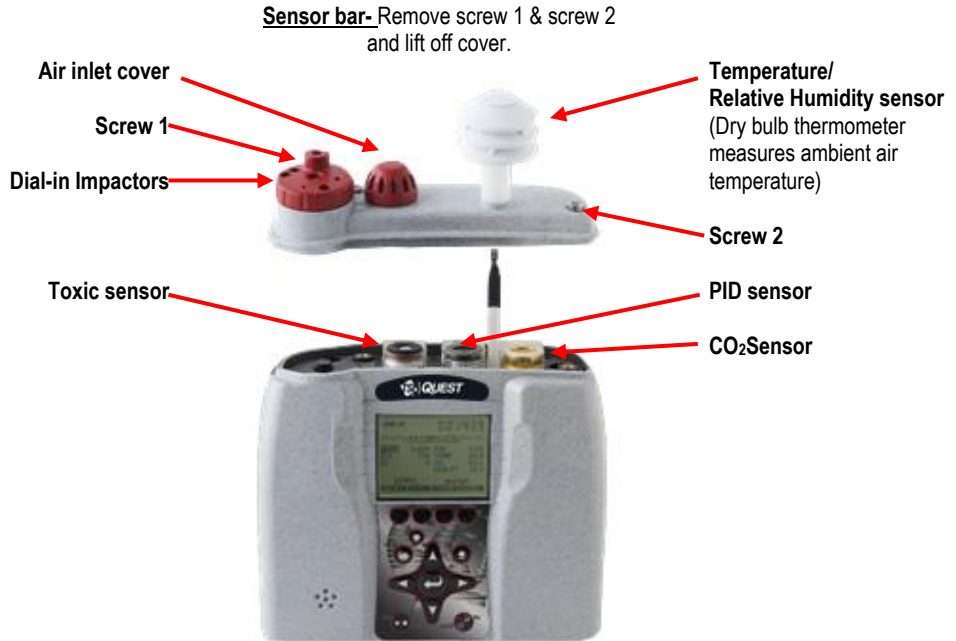

Figure 4-1: Sensor housing and manifold

5. To insert a sensor, gently push the sensor's pins into the socket pin of the circuit board so it aligns accordingly. It will fit securely.
6. To remove a sensor, pull the sensor up horizontally and remove it from the sensor chamber.
7. When completed, replace the black manifold over the sensors and then place the cover over the sensor housing. Tighten the screws back into place.



**Figure 4-2: Sensors' locations**

- ☑ **NOTE:** The Temperature/ Relative Humidity sensor is not user removable.
- ☑ **NOTE:** The user will receive a message on the display when a new sensor is detected or an existing sensor is no longer detected.

## Calibrating Particulates

The EVM is factory calibrated to the "Arizona Road Dust" (also called "ISO Road dust" ISO 12103-1 A2 Fine) standard.

Before you measure particulates, it is recommended to calibrate to the environment you are in. If you are in an ARD environment, you would adjust the impactor to correlate with a specific particulate setting, run a calibration based on the particulates in that environment, and compare the results against the ARD calibration. If you are in any other environment, you would calibrate based on the environment you are in by determining a correction factor (also called "K-factor") to the correct variation from the ARD calibration standard.

The EVM supports eight different user profiles. Each profile stores a customizable profile name field, and a correction factor. (Setting-up profiles/correction factors is discussed in the Set-up chapter, “Setting profiles for particulates”).

The following sections will walk you through how the impactor operates, how to adjust the impactor, how to run a zero calibration, and lastly running a gravimetric calibration.

## Impactor and use

The impactor is a device used to remove larger sized particulates from the air-stream you are measuring.

**How does it operate?** Air travels through the impactor and the heavy particulates will stick to the greased plates within the impactor (1). The Pump will circulate the air as it passes through the tubing in the back of the instrument (2). The smaller, lighter particulates will pass through the optical engine (3) and collect in the gravimetric filter/cassettes (4).



Figure 4-3: How the impactor functions

☑ **NOTE:** Depending on the environment (i.e., a dense, dusty manufacturing plant), you will want to ensure the impactor is well greased and cleaned before using. Additionally, it is recommended to monitor this process while measuring. You may need to stop your measurements, clean and grease the impactors, and then resume measuring. To clean and grease the impactors, see [Chapter 7](#) “Cleaning and maintenance”.

## Adjusting the Impactor/Turret Setting

When measuring, the industrial processes (such as sanding, cutting, crushing, grinding, and transportation) cause air pollutants. The size of the particles will enter the human body in different areas, affecting the nasal, throat, and/or lung area.

The impactor setting is used to trap and filter out the larger size particles based on your cut-point (or impactor setting). The range is programmed between 1  $\mu\text{m}$  to over 100  $\mu\text{m}$ . For example, if you are measuring coal dust (aimed at the lung area), you would adjust your impactor setting to PM10. The following are the user-selectable cut-points:

- PM2.5, PM4, PM10, or PM (all dust ranging from 0  $\mu\text{m}$ -100  $\mu\text{m}$ )
- NOTE:** The particulate size is written on top of the turret. For PM there is no marking but is noted by the (raised) air chamber.
- **Adjust impactor/turret for particulate logging**
1. Using the keypad navigate to the particulate or composite measurement screen.
    - **How to?** From the Start screen, press the **Right** arrow key.

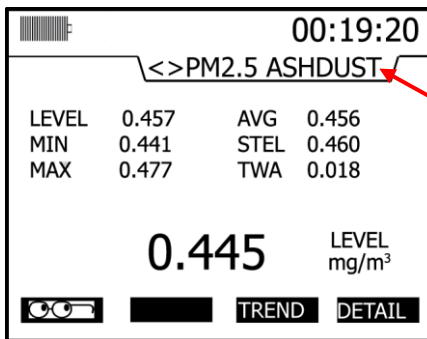

**PM 2.5 & profile displayed**  
Impactor setting updates as the turret is rotated (when in stop mode)

Figure 4-4: PM2.5 impactor setting example



- Twist the turret (red casing around the impactor) to the left or right until you see the appropriate setting on the display. It will align to the impactor text and arrow on top of the housing.
- ☑ **NOTE:** The actual diameter of the air inlet hole is directly to the left of the impactor text positioning.

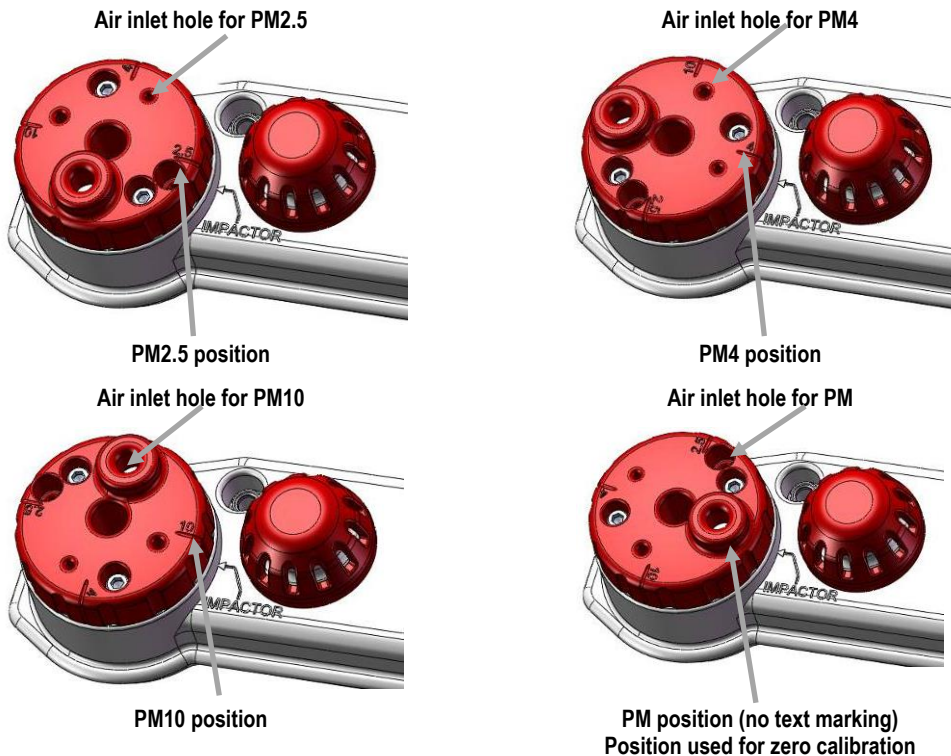

Figure 4-5: Adjusting impactor/turret setting

- If you see "< >PM ERR", this indicates the impactor is not in the correct position and that it is between two positions. Adjust the turret, until the correct reading is displayed on the screen.

## Particulates Calibration (Zero Cal)

A zero calibration is recommended the first time you measure particulates in the run mode. For particulate calibration, place a zero filter (also called a HEPA filter) with attached coupler into the vent of the turret. The impactor setting must be set at PM in order to conduct a zero cal.

- ☑ **NOTE:** For the span on the particulate calibration, refer to the "Gravimetric Filtering" instructions to determine the gain factor from the correction factor.

### ➤ Particulates zero cal

- Insert the attached coupler and zero filter into the turret. Ensure the **impactor is well-greased** before calibrating which requires a thin film of grease. (See "[Impactor care](#)" for details).



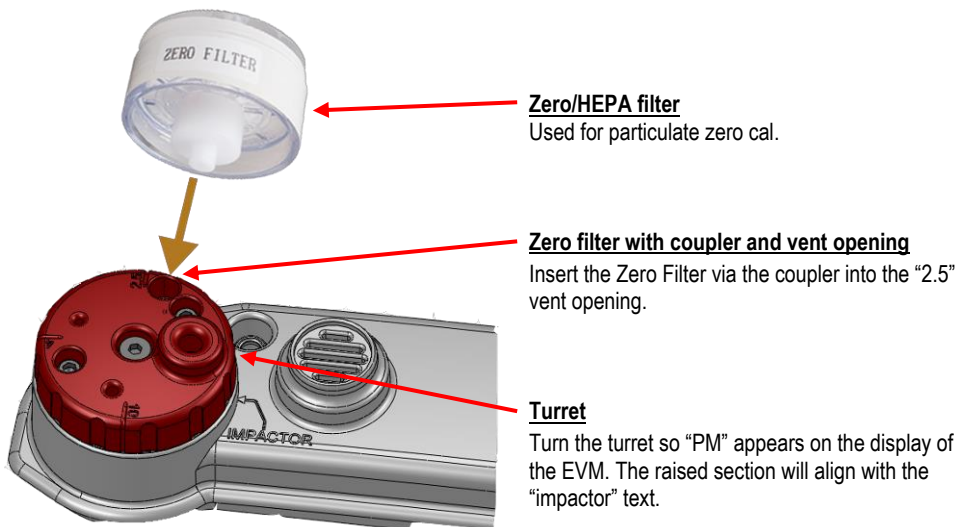

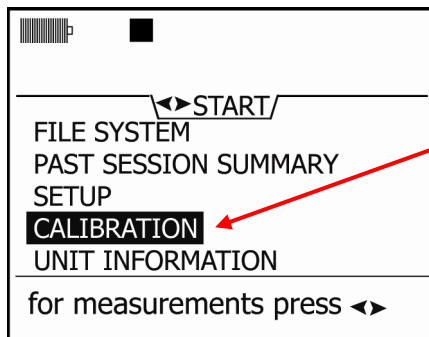

Figure 4-6: Particulate zero cal with HEPA filter

2. Adjust the turret/impactor to **PM** (refer to “Turret” in Figure 4-6).
3. From the **Start** screen, press **▲/▼ Arrows** until **Calibration** is selected and press **Enter** .



**Calibration** – select to open to the Calibration set screen

Figure 4-7: Selecting calibration screen

4. In the **Calibration** screen, press **▲/▼ Arrows** and select **PM** (for particulate matter).
  - NOTE:** If the impactor setting is incorrect, the instrument will flash a warning sign indicating that you need to turn the impactor to “PM” before proceeding.

5. Press the **Cal** soft key. (The pump will turn on.)  
 **NOTE:** The **HISTR** and **VERIFY** soft keys will not be present if a user calibration and a calibration verify have not been performed.

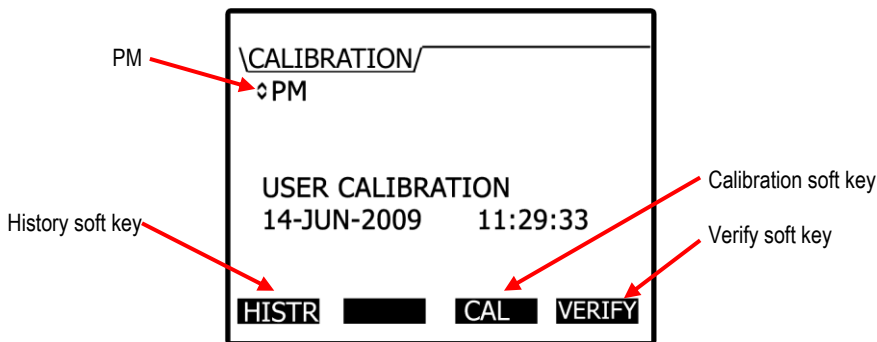

Figure 4-8: Particulate cal screen

6. The ready screen with the PM, Profile will appear. Press the **Start** soft key.

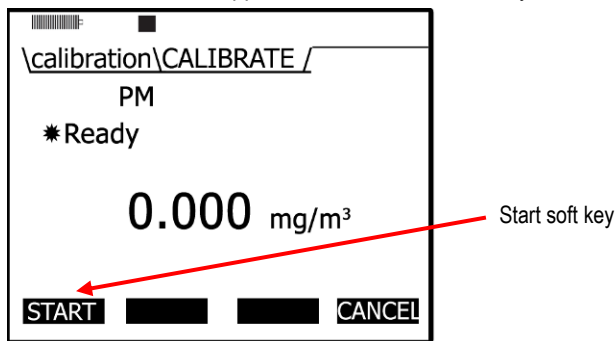

Figure 4-9: Particulate calibration and ready screen

7. Allow the level to stabilize (approximately 1–3 minutes). It will state **Waiting** (A) and **Set** soft key will appear when it has stabilized (B).

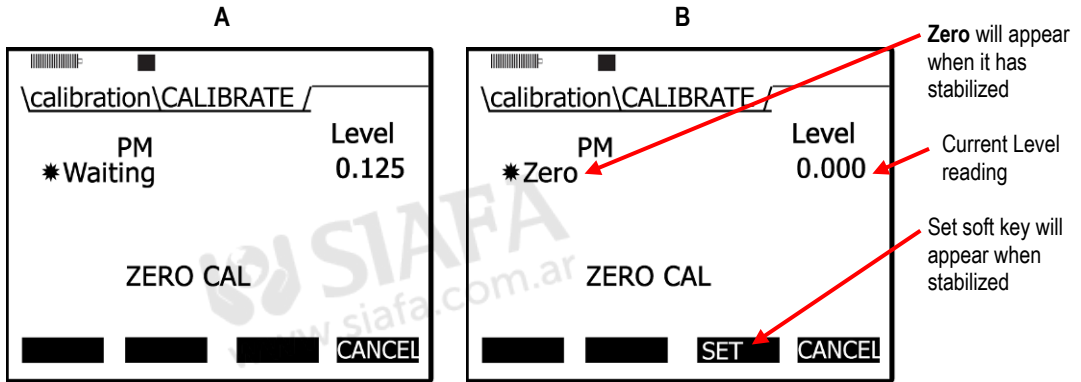

Figure 4-10: Particulate calibration and waiting screen

8. Press the **Set** soft key to set the **Zero cal** point.
9. The instrument will show a **Pause** state with the intended and actual values.

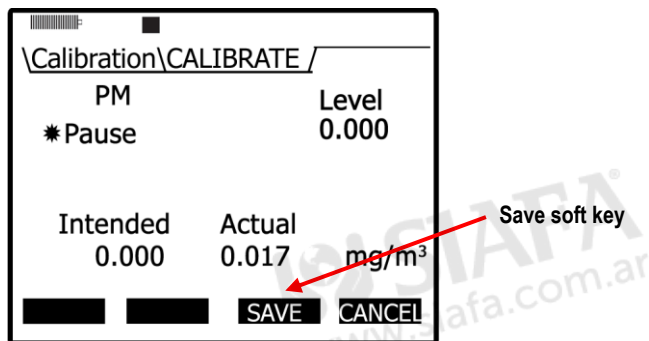

Figure 4-11: Particulate calibration pause screen

10. Press the **Save** soft key to save your calibration (or press Cancel and Retry to repeat this process.) A screen pop-up will state “Zero cal set point” when completed (or “User canceled calibration”). A pass (cancel) screen will be displayed.

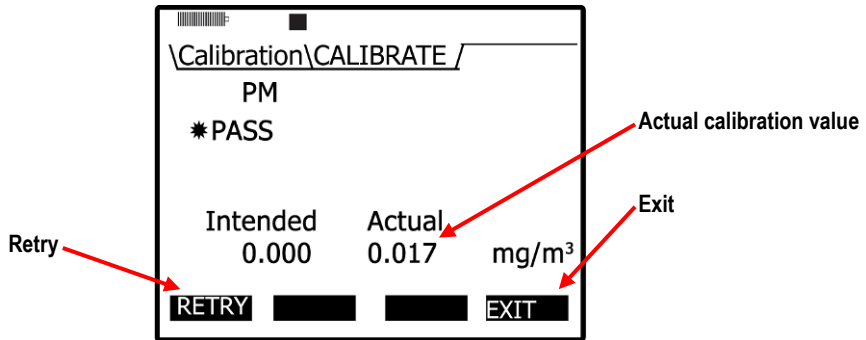



Figure 4-12: Zero Cal set for Particulates

- Press **Retry** soft key to repeat the zero cal procedures.
11. Press **Exit** soft key to close this screen. To return to the start screen, press **On/Off/Esc**  or press the **Cal** soft key to continue calibrating the sensors.
- NOTE:** A zero cal is performed for the instrument and will be used for all profiles.

## Particulate Advanced Calibration (Gravimetric)

With the EVM, you can store up to eight different profiles (also called correction factors) to reflect the environment or building zone you plan to measure.

The instrument is factory calibrated to Arizona Road dust. In some situations, you may want to perform a gravimetric calibration in order to determine the correction factor for an alternative environment. This is an optional procedure.

- NOTE:** If you do not plan on performing an advanced particulate calibration with gravimetric sampling.

With a gravimetric calibration, you determine the mass of the particulate you want to measure. The particulate mass is then used to calculate a correction factor to the environment you will be measuring. The steps below outline a gravimetric calibration.



(For additional specifications on a gravimetric calibration, please refer to the NIOSH 0600 standard.)

### Gravimetric Calibration Overview

1. Reset the gravimetric and volume accumulators.
2. Insert a new (sealed) gravimetric cassette.
3. Measure in the specific location for approximately four to eight hours.
4. Proceeding the measurement, the gravimetric accumulator on the EVM will display the amount of dust that has accumulated based on the active profile. (This value is used in conjunction with the weight of the measured dust in the cassette.)
5. To determine the weight of particulates in the gravimetric filter, remove the gravimetric cassette and weigh the contents. (Typically, sent to a lab for results.) Do not include the weight of the cassette.
6. To determine the correction factor, calculate the ratio between the particulate mass value and the weight from the gravimetric filter lab analysis.
  - ☑ **For example**, let's say that you measured for 8 hours in a wood shop and the PM mass accumulator displays 10 mg. Next, you measured the dust in the gravimetric filter/cassette and determined the weight as 20 mg. To calculate the correction factor, you divided 20 mg by 10 mg and determined the value as 2. Lastly, the correction factor of "2" is multiplied by the existing active profile correction factor, and is entered as the new correction factor (Setup\PMEDIT

## Performing a Gravimetric Calibration

Ensure the gravimetric cassette is new before beginning.

1. Place the instrument in the appropriate environment.
2. Turn on by pressing **On/Off/Esc** .
3. In the **Start** screen, select the **Setup** menu and press **Enter** . Next, select **Particulates** by pressing the **Down arrow** repeatedly and once selected, press **Enter** .
4. In the particulate screen, the reset gravimetric accumulator fields will display either a value of the collected dust or it will display zero (if already reset). When beginning a gravimetric calibration, ensure this is set to zero.

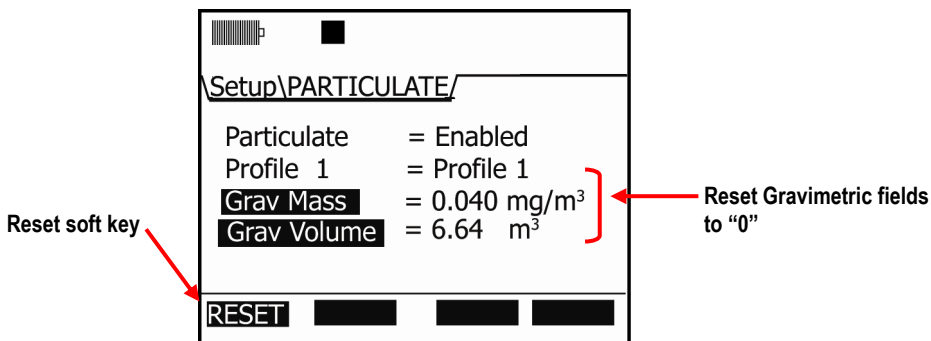



Figure 4-13: Reset gravimetric setting

- To reset, press the down arrow repeatedly to select the gravimetric fields and press the **Reset** soft key. (If it is not displayed, press the **AltF** key.)
5. Turn the pump on by pressing the **Pump**  key.
  6. Optional step:
    - a. It is optional to press the **Run/Stop** key to log the gravimetric filter sampling.  
 **NOTE:** If in “run mode”, a clock appears and displays the overall run time.
    - b. To view the particulate level, press the right arrow once from the start screen and the particulate measurement screen will appear (noted as “PM”).
  7. After the gravimetric collection, turn the pump off and reference the **Gravimetric Mass** field to view the calculated particulates.
  8. Lastly, calculate the ratio between the value in the **Gravimetric Mass** field and the weight of the collected sample.
  9. Enter in the correction factor via the **Particulate Setup** screen (see “[Setting Profiles](#)” section for more details).

## Pump Flow Rate Calibration

An accurate flow meter, such as a primary standard flowmeter calibrator, and inert tubing is required to perform this calibration. The inert tubing is inserted on the dust air flow outlet (located on the back of the housing).

- NOTE:** You may want to send the instrument in for a yearly calibration, if you do not own a flowmeter calibrator for this calibration procedure.

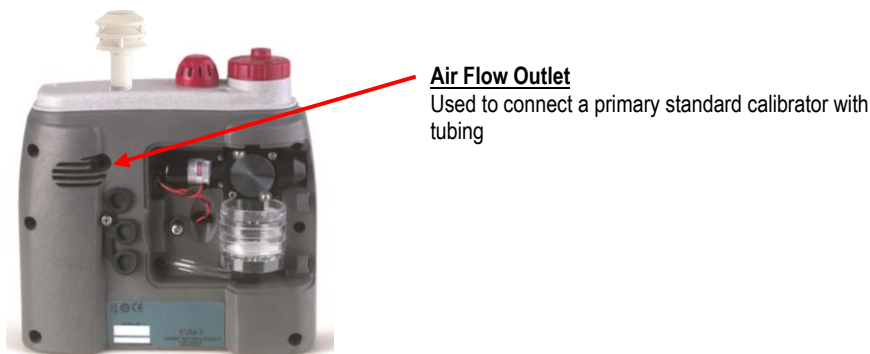



Figure 4-14: Pump flow rate calibration

- **Flow rate calibration**
1. Connect the flow meter (i.e, primary standard) and inert tubing to the EVM.
  2. Turn the EVM on by pressing **On/Off/Esc** .
  3. Select the **Calibration** menu by pressing the **Down Arrow** until it is selected and press **Enter** .
  4. Select **Flow Rt** (flow rate) by repeatedly pressing **▲/▼ Arrows** key until it appears.

5. Press the **CAL** soft key and then press the **Start** soft key.

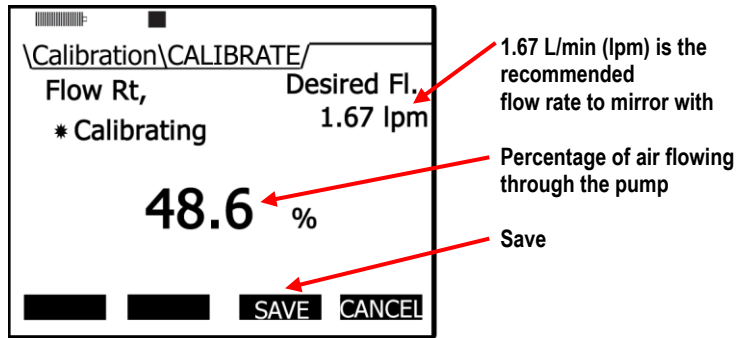



Figure 4-15: Flow Rate Calibration

6. Manually adjust the flow rate (as needed) by repeatedly pressing the **Up/Down** key to select the desired level.
7. Press the **Save** soft key to store this as your flow rate calibration. The flow rate summary will appear.
  - NOTE:** You may want to repeat these steps if the desired level was not achieved. Press the **Cancel** soft key to stop the calibration. Next, press the **Retry** soft key and repeat the calibration steps to re-cal the flow rate.
8. Press the **Exit** soft key to exit this screen. (The pump will turn off.)
9. Press the **On/Off/Esc**  key to return to the start screen.

## Toxic Gas Sensors

The gas sensor chamber will allow you to measure any one of the single toxic gases listed below. Refer to [Appendix A](#) for detailed specifications.

1. Carbon monoxide (CO) with a range of 0–1000 ppm
2. Chlorine (CL<sub>2</sub>) with a range of 0–20 ppm
3. Ethylene oxide (EtO) with a range of 0–20 ppm
4. Hydrogen cyanide (HCN) with a range of 0–50 ppm
5. Hydrogen sulfide (HS<sub>2</sub>) with a range of 0–500 ppm
6. Nitrogen dioxide (NO<sub>2</sub>) with a range of 0–50 ppm
7. Nitric oxide (NO) with a range of 0–100 ppm
8. Oxygen (O<sub>2</sub>) with a range of 0–30%
9. Sulphur dioxide (SO<sub>2</sub>) with a range of 0–50 ppm
10. Ozone (O<sub>3</sub>) with a range of 0–1.0 ppm

The sensors are based on well-established electrochemical sensor technology. They are designed to be maintenance free and stable for long periods of use.



## Cross Sensitivity

The following table illustrates the cross-sensitivity to a range of commonly encountered gases, expressed as a reading of the sensor when exposed to 100 ppm of the interfering gas at 20°C.

Gas	Interfering Gas											
	CO	H <sub>2</sub> S	SO <sub>2</sub>	NO	NO <sub>2</sub>	H <sub>2</sub>	CL <sub>2</sub>	HCN	C <sub>2</sub> H <sub>4</sub>	HCl	CL	O <sub>2</sub>
CO	100	~ 7	<10	<9	<20	<40	N/D	N/D	N/D	N/D	N/D	N/D
H <sub>2</sub> S	<2	100	~10	~1	~20	~1	N/D	N/D	N/D	N/D	N/D	N/D
NO <sub>2</sub>	-5	<5	<-.5	0	100	N/D	N/D	N/D	N/D	N/D	N/D	N/D
NO	0	N/D	~ 5	100	<30	N/D	N/D	N/D	N/D	N/D	N/D	N/D
HCN	N/D	N/D	N/D	N/D	N/D	N/D	N/D	N/D	N/D	N/D	N/D	N/D
NH <sub>3</sub>	0	0	~ 60	~20	<10	0	~-50	~-5	N/D	<10	N/D	N/D
*O <sub>3</sub>	-8	N/D	N/D	N/D	~60	0	~120	N/D	N/D	~150	~150	~150

\*Continuous exposures at ppm level over more than 30 minute might blind the sensor.

**Table 4-1: Cross-sensitivity table of interfering gas**

### How Sensors Operate

Power is automatically applied to the gas sensors when they are connected and the instrument is turned on. These are also referred to as “intelligent-sensors”. Additionally, the EVM will automatically identify the type of gas sensor that is installed.

**NOTE:** It may take a few minutes for a newly inserted sensor to stabilize before using.

## Quality Calibrations

The quality of the calibration process depends upon the accuracy of the calibration gas and allowing the sensors to stabilize before saving the zero and span calibrations.

## About Sensors and Cal Storage

Once a calibration is completed and a sensor is removed, the calibration records are stored in the sensor.

## Calibration History and Sensor Serial Numbers

After running, saving a calibration, and downloading the data to Detection Management Software (DMS), the calibration type, levels, the serial numbers, and the date/time of the calibration are viewable in the software. The serial number of the sensor is available in DMS in the calibration history chart.

Calibration History				
Date	Calibration Type	Sensor Id	Sensor Serial Number	Sensor Level
1/2/2007 6:00:52 AM	Single Point Calibration	2		241
1/2/2007 6:00:09 AM	Dust Calibration	1		28569
1/2/2007 6:01:06 AM	Single Point Cal. Verify	2		241
1/2/2007 6:00:09 AM	Dust Cal. Verify	1		28569

**Figure 4-16: Calibration history for EVM**

## Applying a Gas Sensor

Gather your calibration gas source, the regulator (if not already connected), inert tubing, the cal adapter and the EVM with the appropriate sensors installed. After your calibration setup is completed, follow the preceding applicable calibration sensor sections.

### ➤ Applying a gas sensor

1. Connect the gas source, regulator and inert tubing.
2. Slide the inert tubing over the black nozzle of the cal cup.
3. Remove the **air inlet** cover on the EVM. (See Figure 4-2 for an example).
4. Place the Cal cup over the air inlet.
5. When you are ready to access the **Cal** screen, turn on the regulator.

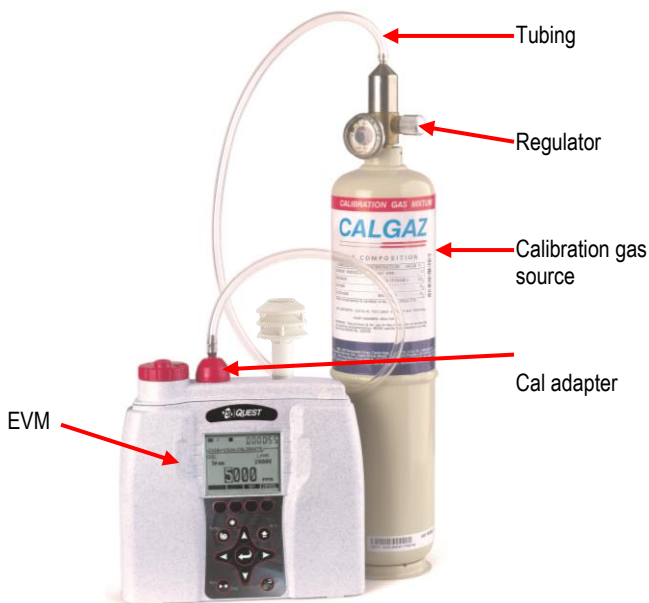



Figure 4-17: Applying a gas sensor

## Calibrating Toxic Gas Sensors

It is recommended to conduct a zero cal and a span cal with toxic gas sensors. Essentially, a calibration is conducted by checking the sensors response to a known concentration of a certified calibration gas. It is important to note that with a zero cal and a span cal, you should be in a non-contaminated environment when performing the calibration.

It is recommended to calibrate on a regular basis for best results. You will want to perform a **zero cal** and a **span cal** (or adjustment) to properly calibrate a toxic sensor.

	<b>Important</b>
	The zero and span adjustment procedures for oxygen are different than other gas sensors.

	Caution
<p>Due to the presence of toxic gas during the calibration process, appropriate safety procedures should be followed.</p> <p>Additionally, you will want to ensure that your calibration is performed in an area known not to contain hazardous or interfering gases if ambient air will be used as the zero gas for operation. If this is not possible, pure bottled air (Nitrogen is recommended) should be substituted. Instructions for both procedures are provided below. You only need to perform one or the other.</p>	

### Toxic Gas Zero Calibration

When conducting a zero cal for toxic gas, you will want to use a cylinder of Nitrogen or pure air with the cal cup placed over the air inlet cover. (See “Applying a gas sensor” for details).



**☑ NOTE:** If you are in clean air environment, you can use room air (for all toxics except for ozone).

### Ozone Calibration for Zero and Span

For an Ozone calibration, a zero calibration is performed with Nitrogen and a span calibration is performed using an ozone generator.

**☑ NOTE:** It is recommended to factory calibrate the ozone sensor on a yearly basis.

#### ➤ Performing a Zero cal for toxic gas

1. While the instrument is powered off, **connect** the pure air cylinder, regulator, inert tubing, and cal cup to the EVM.
2. Power on the EVM by pressing the **On/Off/Esc** .
3. In the start screen, press the **Down ▼** arrow to select **Calibration** and press the **Enter** .
4. Press **▲/▼ Arrows** to select the toxic you want to calibrate.
5. Press the **Cal** soft key and a specific toxic gas (i.e., CO) **Calibrate Set Point** screen will appear.

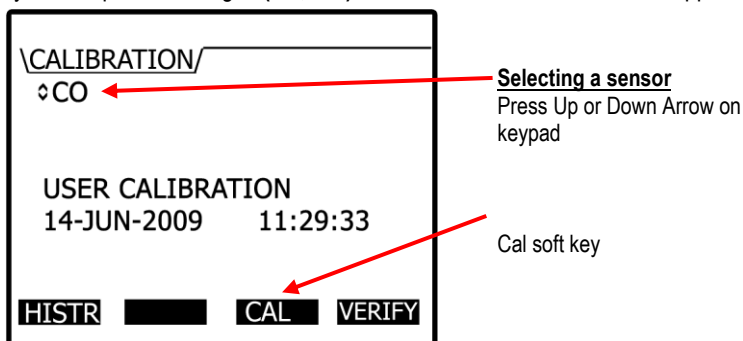

Figure 4-18: Selecting sensor for calibration process

6. Turn regulator **On**. Wait for the current level to stabilize (allow at least 90 seconds to stabilize.) (The screen will show **+Ready**.)
7. When the level has stabilized, press **Zero** soft key.

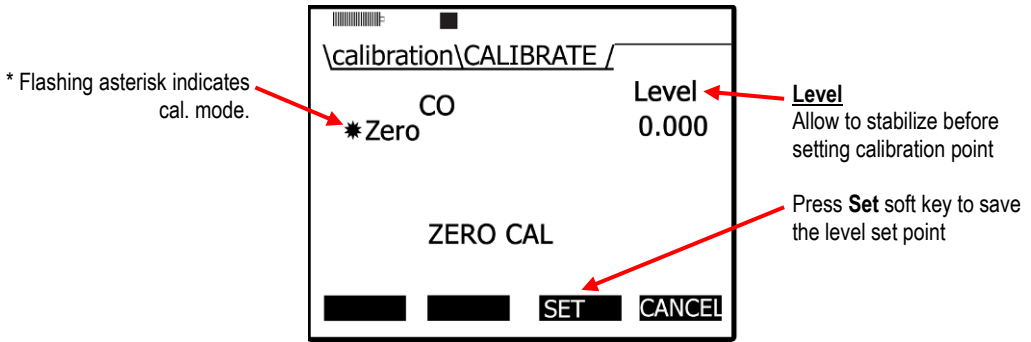

Figure 4-19: Calibration zero screen

8. Press the **Set** soft key. A screen displaying the zero cal intended and actual set point values will appear. Press the **Save** soft key.

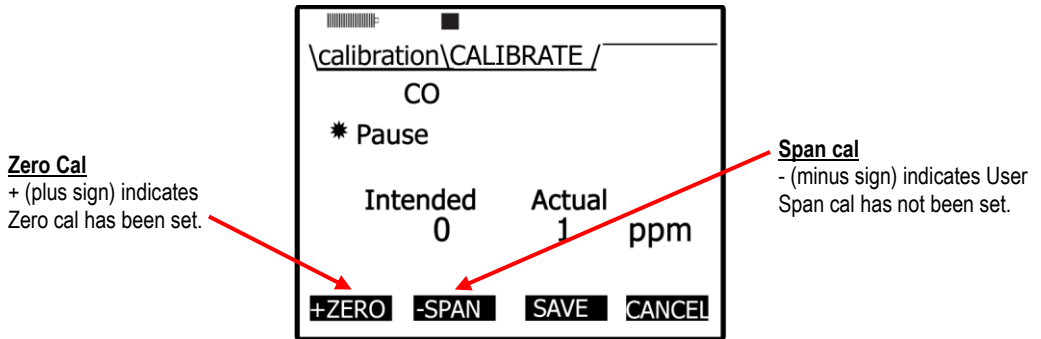

Figure 4-20: Calibration zero pause screen

9. To set the span cal, proceed to “Toxic gas – span calibration”.  
 **NOTE:** To re-do the zero calibration, press the **+Zero** soft key and repeat steps 7 and 8.

Soft keys	Explanation
<b>Cal</b>	When pressed, this will allow a calibration to be performed.
<b>Zero</b>	When pressed, this will enable you to a zero calibration.
<b>Span</b>	When pressed, this will enable you to perform a span calibration.
<b>Exit</b>	Enables you to exit at any time.

Table 4-2: Gas calibration soft keys explained

## Toxic Gas Span Calibration

When conducting a span calibration, the calibrated gas used should match the sensor you will be calibrating.

- ☑ **NOTE:** For Ozone span calibration, an ozone generator should be used.) If you are continuing from the Toxic Zero cal section, the screen you will be viewing is the Calibrate/Pause screen. (If you are performing a Span cal only, ensure you are at the **Start** screen and select the calibrate menu. Then select the specific sensor by pressing up/down arrows. Press the **Cal** soft key and then press the **Span** soft key. Proceed to Step 2.

### ➤ Performing a span cal for Toxic gas

1. Continuing from the zero cal procedures, you should be viewing the **Cal/Pause** screen (as displayed in Figure 4-17). Press the **Span** soft key.
2. **Apply the gas** at full flow rate while observing the “Level” field on the display. Wait for the current level to stabilize (allow a couple of minutes).

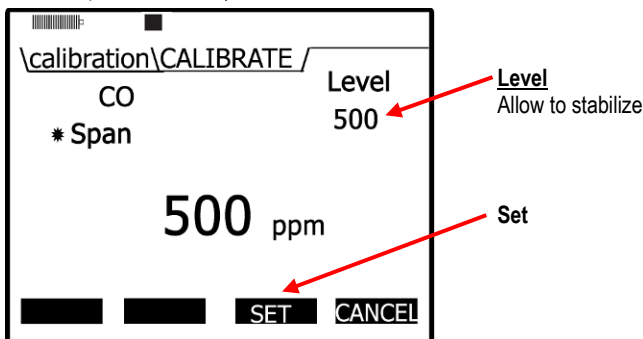

Figure 4-21: Span Calibration

3. Adjust the span value by pressing **▲/▼ Arrows** on the keypad.
4. Press the **Set** soft key to store the span cal. point. (A screen will appear displaying that you set the span cal. point.)

- Once your calibration is set, intended and actual cal values will appear on the display screen. Press **Save** to store these as your calibration set points.

**NOTE:** To redo the span calibration, press the **Span** soft key and repeat steps 2–5.

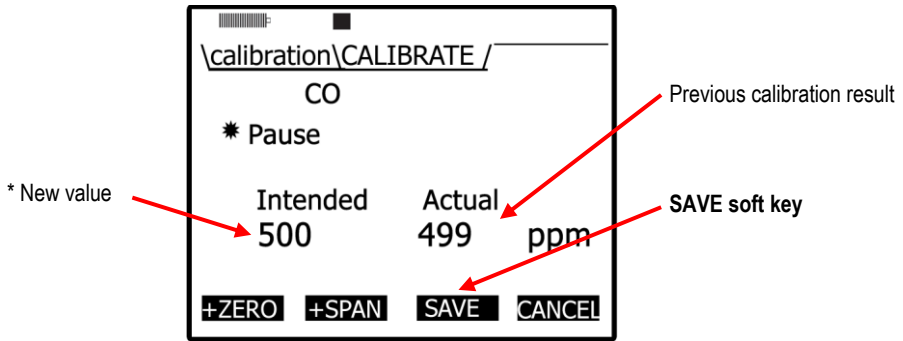



Figure 4-22: Saved Calibration screen

- Turn the regulator off and disconnect the tubing from the instrument.
- Repeatedly press **On/Off/Esc**  until you return to the start screen.
- Press **◀/▶ Arrows** to view measurement screens.

## Calibrating CO<sub>2</sub> AND O<sub>2</sub>

With the Carbon Dioxide (CO<sub>2</sub>) or Oxygen (O<sub>2</sub>) calibration, you may perform a zero calibration and a span calibration (when the cal gas is connected) in the field. Each of these screens will be discussed below.

The CO<sub>2</sub> sensor and O<sub>2</sub> sensor requires a calibration gas, a regulator with at least 1 L/min flow rate and inert tubing.

A zero calibration using a Nitrogen (N<sub>2</sub>) gas is recommended. For a span calibration, the range (or span) should be a sizeable fraction of the selected full scale range of the gas.



### O<sub>2</sub> Accuracy

The range for O<sub>2</sub> sensor is 0–30% with a typical span cal of 20.9%

#### ➤ Calibrating a zero cal and span cal for CO<sub>2</sub> or for O<sub>2</sub> sensor

- Connect** one of the following gases with the regulator and inert tubing:
  - N<sub>2</sub> gas (used for zero cal.)
  - CO<sub>2</sub> calibration gas
  - Room air for O<sub>2</sub> calibration gas (i.e., 20.9%)
- Attach the regulator and tubing to the gas cylinder.
- Place the **Cal. cup** over the **Air inlet cover** and slide the **tubing** over the black air inlet casing.
- From the start screen, press **▼ Arrow** to select **Calibration** and press **Enter** .

- In the **Calibration** screen, press **▲/▼ Arrows** to select CO<sub>2</sub> or O<sub>2</sub>.

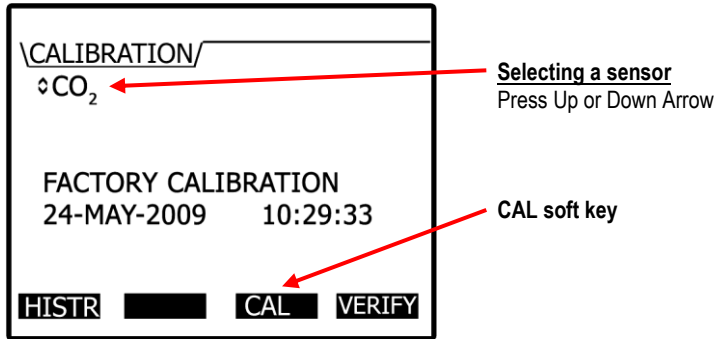

Figure 4-23: Selecting a calibration sensor

- Press the **CAL** soft key to open the CO<sub>2</sub> “Calibration/Calibrate” screen. (Allow at least 2.5 minutes for CO<sub>2</sub> to stabilize.)
  - For the Set Points, **-zero** and **-span** soft keys will appear. Press either **Zero Cal** or **Span Cal** soft key. (See Table 4-2 for more information.)

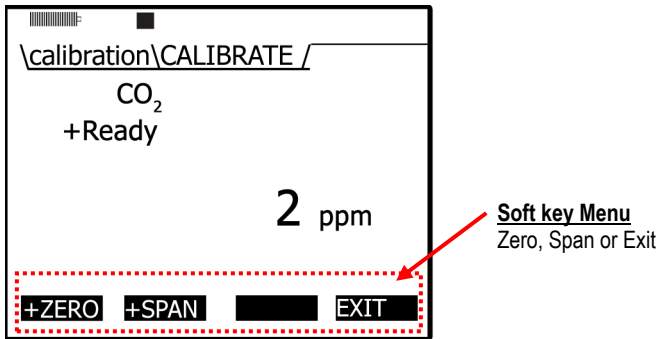

Figure 4-24: Calibration CO<sub>2</sub> ready screen

- NOTE:** If “-” (a minus sign) appears in front of Zero or Span, this has not been calibrated. Alternatively, the “+” (plus sign) signifies the cal point has been calibrated.
- Turn the regulator on. The regulator should have a flow rate of 1.0 L/min.
  - Allow the level to stabilize. For CO<sub>2</sub>, wait at least two minutes to stabilize.
    - For Zero Cal, the screen will display Zero with a Set soft key.
    - For span cal, press **▲/▼ Arrows** on the keypad to adjust the appropriate level.

9. Press the **Set** soft key. Turn off regulator and unhook the N<sub>2</sub> bottle (for zero cal) or CO<sub>2</sub> bottle (for span cal). (To perform a Zero or Span cal, repeat steps 1–8.)  
 **NOTE:** To redo a zero or span calibration, press the zero or span soft key and repeat steps above to program new set points.

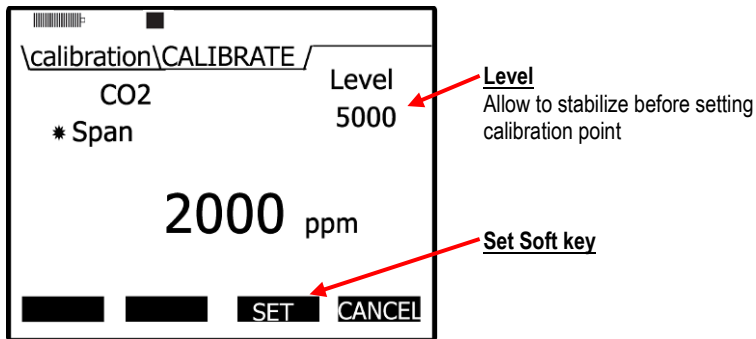

Figure 4-25: Setting CO<sub>2</sub> Span Cal screen

10. Once the zero and span cal values are set, the calibration save screen will appear. Press **Save** to save your calibration.  
 **NOTE:** To repeat the cal, press the **Cancel** soft key and you will return to the calibration screen. Repeat the steps above to program new set points.

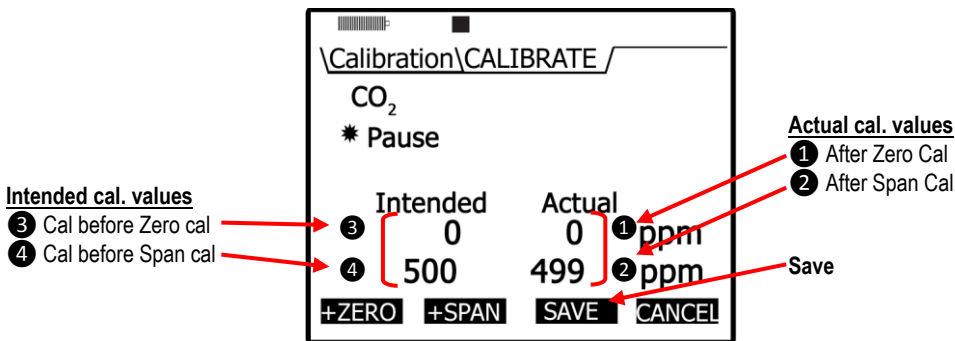



Figure 4-26: Saved Calibration

11. Once saved, the display will indicate if it passed. You have another option to **Retry** the calibration procedure by pressing the **Retry** soft key.
12. To exit CO<sub>2</sub> calibration, press the **Exit** soft key.
13. Then, press **On/Off/Esc**  twice to return to the **Start** screen.



## Calibrating Photo-Ionization Detector (PID) Sensor

### PID parts per million (ppm) zero calibration

It is preferred to flush the PID ppm sensor with Zero Grade Air for a zero calibration. Alternatively, you may flush the PID ppm sensor with Nitrogen. In clean environments (with no presence of toxic chemicals, such as in a school setting with no toxic cleaners present) applying room air can be used to set your zero calibration point.

For the flow rate, it is recommended to set it at 1 L/min for best response time.

### PID parts per billion (ppb) zero calibration

☑ **NOTE for PID ppb sensor:** The PID ppb sensor may be susceptible to baseline settlement after more than 2 weeks of storage. In these cases, the PID PPB sensor should be operated in clean air for several hours prior to performing a calibration and prior to performing measurements of low concentration of gases (< 1000 PPB).

The PID ppb sensor uses a static base line for the zero offset. If the user adjusts zero base line, the PID ppb needs to be enabled in the setup menu.

☑ **NOTE:** To enable, select **Setup** from the main screen and then choose PID. In the PID screen, enable the ppb zero feature. Once set, return to the calibration screen to resume the calibration process. (For more details on setting, refer to “PID sensor setup” in [Chapter 3](#).)

#### ➤ PID ppm/ppb zero cal

1. **Connect** the Zero Grade Air and cal cup to the EVM. (Skip this step if you are not applying a gas.)
2. From the **start screen**, press the **Down ▼** arrow to select **Calibration** and press **Enter ↵**.
3. Press the **▲/▼ Arrows** to select the **PID** sensor.

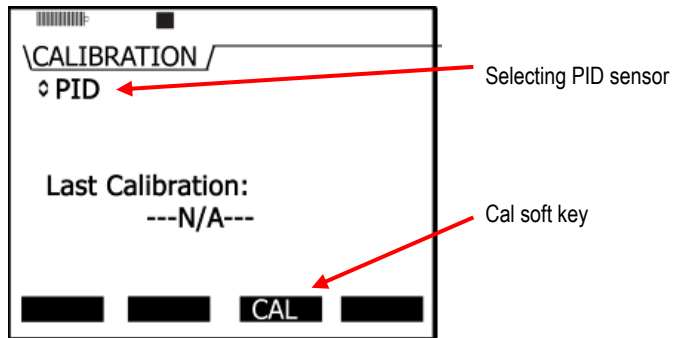
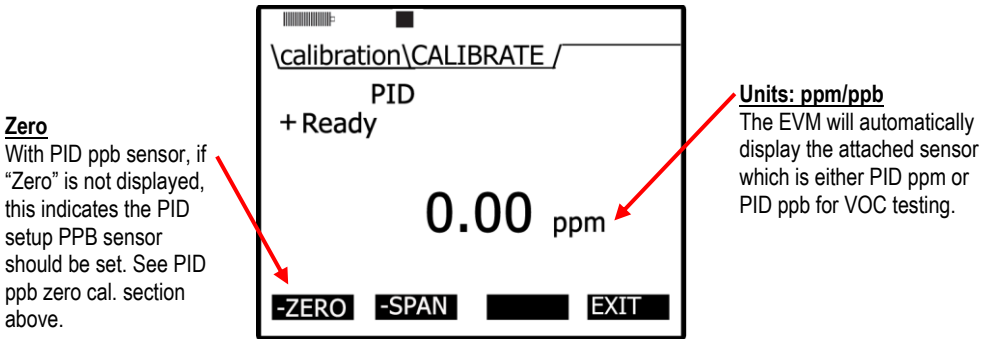
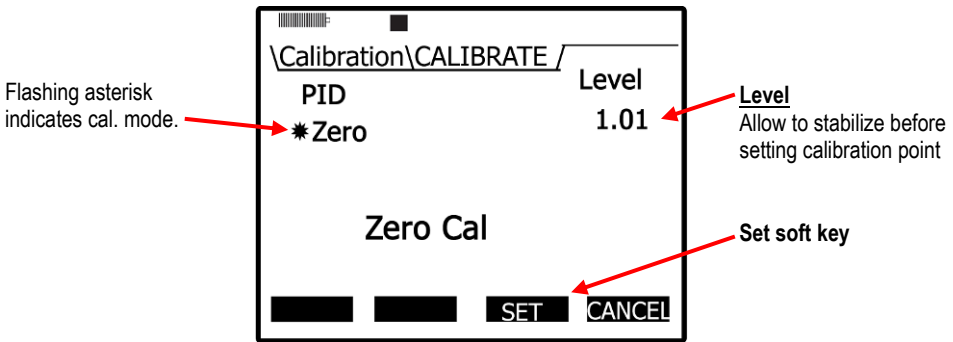

Figure 4-27: Selecting PID sensor for calibration process

4. Press the **Cal** soft key and the **Calibrate PID/Ready** screen will appear. Press **Zero** soft key.  
 **NOTE:** Allow at least 60 seconds to stabilize.



5. When the level has stabilized, press the **Set** soft key. (Or press **Cancel** soft key and then **Retry** soft key to repeat this process.)



**Figure 4-28: Calibration mode screen**

6. The **PID/Pause** screen will appear displaying the intended and actual calibration values. Press the **Save** soft key. (Or press the **Cancel** soft key to repeat this process.)
  - To set the span cal, proceed to "PID – span calibration".
7. To restore the factory calibration for the ppb sensor, select the **HISTR** soft key from the PID calibration screen. Press the **FACTRY** soft key. This restores the ppb zero calibration value.

### **PID Span Calibration**

Typically for PID 100 ppm, isobutylene is used for a span calibration when the VOCs are unknown or apply the gas of interest if detecting a specific VOC for best results.

To measure a specific VOC with PID PPM sensor, you will want to use the relevant VOC for your calibrated gas source. However, for PID PPB span calibration, it is recommended to use 10 ppm (or 10,000 ppb) isobutylene whether the gas of interest is known/unknown.

- ☑ **NOTE:** A correction factor is a number that relates to the PID sensor of a specific VOC and correlates to the PID response to the calibration gas (sometimes referred to as a response factor). Please reference [Appendix C](#) for specific correction factors provided by Ion Science.

### Performing a PID Span Calibration

Allow up to 15 minutes of warm-up time for PPB PID sensor and 5 minutes for PPM PID sensor. For PPB span calibration, refer to PID ppb note if the sensor has not been used for over two weeks.

If you are proceeding from the Zero cal section, the screen you will be viewing is the **Calibrate/Pause** screen. (If you closed the screens, refer to the Note in step 1.)

#### ➤ PID Span Cal

1. From the **PID/Calibrate Pause** screen, press the **Span** soft key on the keypad.
  - ☑ **NOTE:** To navigate to the PID Span cal screen, select the **Calibration** screen. Select **PID** using the up/down arrows. Then, press the **Cal** soft key. Zero and Span soft keys will appear. It will look similar to the screen below but it will not have the intended/actual zero cal set points displayed. See step 2 to proceed.

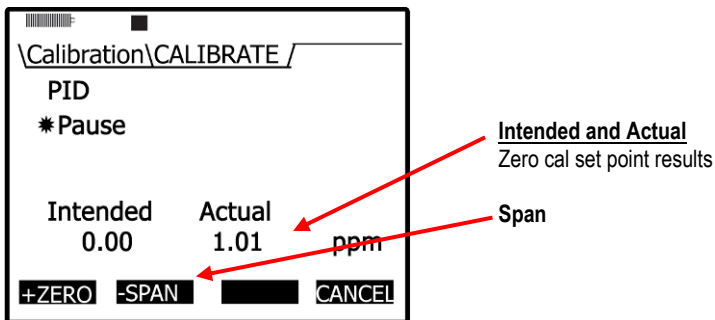

Figure 4-29: PID Calibration Span soft key

2. Adjust the span value by pressing **▲/▼ Arrows** once the sensor has warmed-up.
3. **Apply the gas** at full flow rate while observing the “Level” field on the display. Wait for the current level to stabilize (allow a couple of minutes).
4. Press the **Set** soft key (and it will state Cal set point stored).
5. Once your calibration is completed, a **Save** screen will appear with the details of your parameters.
  - ☑ **NOTE:** If you want to repeat the span cal, press cancel and a message will appear stating it is canceling. Press the **Retry** soft key to repeat the span cal steps.

6. Press **Save soft key** to store this into the memory.

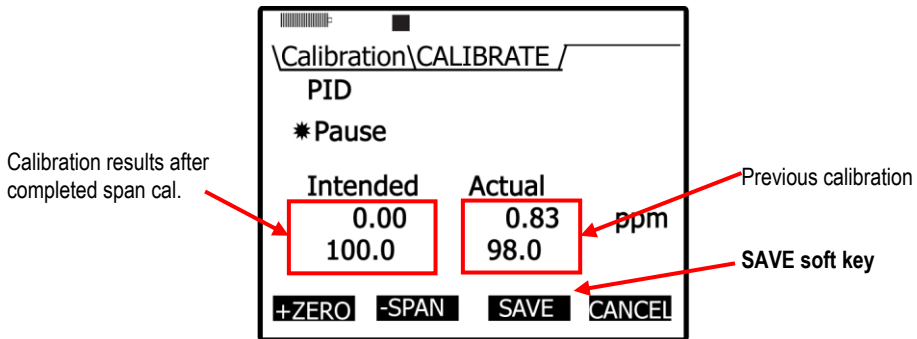



Figure 4-30: Saved Calibration screen

7. Turn the regulator off and disconnect the tubing from the instrument.
8. Repeatedly press **On/Off/Esc**  until you return to the start screen. (Press right or left to view measurement screens.)

## Calibrating Relative Humidity and Temperature

The relative humidity and temperature sensors are factory calibrated. To perform a calibration, you would place the instrument into the location you will be testing with the appropriate temperature sensing instrument (such as a thermometer for a temperature calibration). Then, access the calibration screen and allow the Relative Humidity and Temperature readings to stabilize. Preceding the calibration level, you then store these values.

**NOTE:** When performing a user calibration on Relative Humidity and Temperature, **do not** externally power/charge the instrument. If you are currently charging or using an external power adapter, disconnect before proceeding.

### ➤ Relative Humidity or Temperature calibration

1. Open the **Calibration** screen.
2. Press **▲/▼ Arrows** and select either RH or Temperature calibration.
3. Select the **Cal** soft key and then press the **Start** soft key.
4. Adjust the level to match the current value of a calibrated temperature sensing instrument.
  - To adjust the level, press **▲/▼ Arrows** until the appropriate value is selected.
5. Press the **Set** soft key and a **Save** screen will appear.

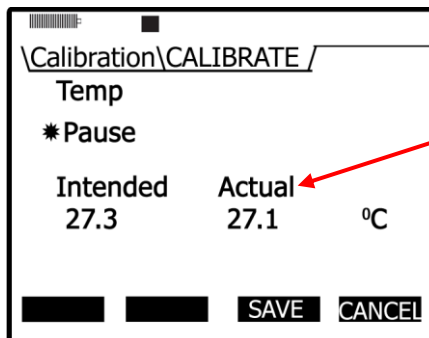

6. Press the **Save** soft key to save the calibration.



Temperature cal

- Intended & actual readings

Figure 4-31: Temperature calibration

7. To calibrate the other sensor (RH or Temp), repeat these steps.
  - Or press the **Exit** soft key and then press **On/Off/Esc** .
  - To open the calibration screen: from the start screen, press the **Down ▼ arrow** to select Calibration and press **Enter** . The Calibration screen will appear.
8. To exit and return to the main screen either press the **On/Off/Esc**  twice.

## Calibration History

The calibration history screen will show your previous calibration of a specific sensor. When the sensor is selected, the last calibration performed will be shown. To view the calibrated values, an optional History menu is selectable via a **History** soft key. The figure below is an example of a CO<sub>2</sub> cal. history.

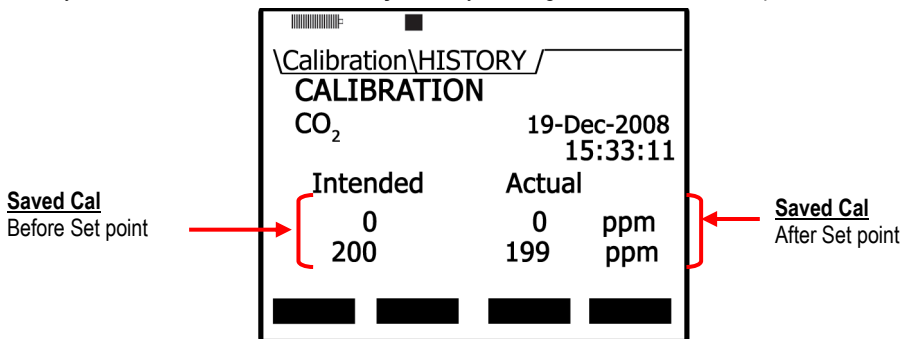



Figure 4-32: Calibration History screen

### ➤ Accessing the Calibration history screen

1. Select the **Calibrate** menu from the start screen and then choose a sensor.
  - ☑ **NOTE:** Press **up/down arrow** in the calibrate menu to select a sensor.
2. If the sensor selected was recently field calibrated, the **History** softkey menu will appear along with the date and time of the last calibration.
3. Press the **HISTR** soft key to view the saved calibration results.

4. To exit and return to the start screen press **On/Off/Esc**  twice.

## Verify Calibration and Drifting Analysis

The verify screen is typically used to analyze drifting. This process verifies if the zero calibration remained stable or unchanged during the run-time/logging time. If it did not remain stable, you can set a new calibration offset and save this as your new set point.

### ➤ Verify calibration

1. Select the **Calibration** menu from the start screen and select a sensor you want to verify.  
 **NOTE:** Press **up/down** arrow menu to select a sensor in the calibration menu.
2. Press the **Verify** soft key. (The Calibrate offset will display on the screen.)  
 **NOTE:** For this example, PID sensor was selected in step 1. If you selected a different sensor, the screens will look very similar to the figures below.

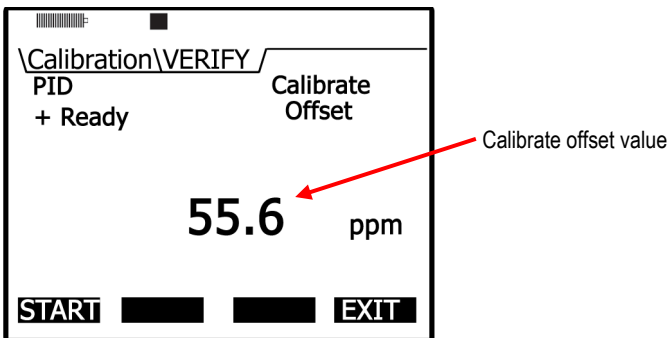

Figure 4-33: Calibrate offset verify screen for PID sensor

3. Press the **Start** soft key and allow the level to stabilize. (Apply any gas if applicable as described in the Calibration sections above.)
4. Press the **Set** soft key to set a new calibration value.

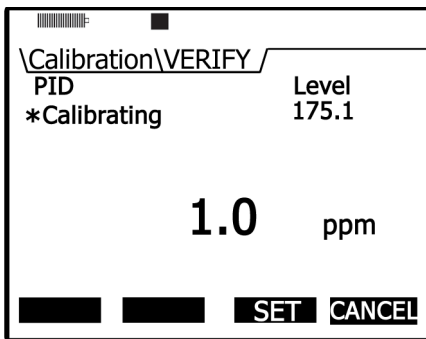



Figure 4-34: Calibrating PID

69 | Placement and Calibration of Sensors  
*Verify Calibration and Drifting Analysis*

5. The Intended and Actual values will appear. Press the **Save** soft key to save these new values.
  - Or press the **Cancel** soft key and press **Retry** to repeat this process.
6. To return to the start screen, press **On/Off/Esc**  twice.
  - To retry the offset cal, press the **Retry** soft key and repeat the steps above.

*(This page intentionally left blank)*





# Measuring and Viewing

Once you have setup your logging parameters and calibrated the instrument, you are ready to begin measuring. The focus of this chapter is to give you a brief overview of what is measured, how to navigate, what measurements screens will appear, and how to run and stop your measurements. The chapter concludes with an explanation of the file system management functionality which is comprised of the following: reviewing past measurements, deleting files, viewing file storage and memory, and viewing the estimated run-time.

☑ **NOTE:** The subsequent sections show examples of views which you may have disabled on your instrument (refer to [Chapter 3](#), “Setting-up the EVM” for more details).

## Overview of Running a Session

The list below is a brief overview of the steps for running a study.

### Quick Help

#### Quick Help List: typical gas/particulate/air quality overview



1. Turn the EVM on and check your battery power (see Chapter 2).
2. **Reset/Clear** memory (if necessary).
  - This will clear out all of the data history before your study begins to ensure you have sufficient memory space.
3. Set-up your study parameters (see Chapter 3).
4. Calibrate each sensor/parameter (see Chapter 4).
5. Place the EVM in a specific location for area monitoring.
6. Press the **Run/Stop**  key to start the study (see Chapter 5)
7. When you are ready to end your study, press the **Run/Stop**  key to stop the study.
8. Review your results either on the instrument or download to DMS for further analysis (graphs/charts, saving and printing).

Figure 5-1: Quick help list for running a study

## Measuring

Once you have placed the Environmental Monitor (EVM) in a specific location, you are ready to take measurements.

With a couple pushes on the keypad buttons, you will be running and viewing your sessions. Following your sessions you can load the data/files into DMS to manipulate, analyze, save, and create reports (See [Chapter 6](#) for viewing your logged data in DMS).

## Understanding What Data is Stored

When you are performing air quality monitoring, there are two types of data stored in the instrument which includes summary data and time history data (or logged data).

### Summary Data

Summary data represents values that occurred over the entire run of the study. An average measurement is the average of all arithmetic data points for a sensor (i.e., dust, humidity, CO, etc.), Max and Min values are the highest and lowest measurements that occurred throughout the run time.

Description	Value
Temp Avg	26.9 °C
Temperature Min	26.9 °C
Temperature Max	26.9 °C
Temp Min Time	2/22/2010 2:36:54 PM
Temp Max Time	2/22/2010 2:38:16 PM
Humidity Max	20.7 %
Humidity Avg	20.5 %
Humidity Min	20.4 %
Humidity Max Time	2/22/2010 2:36:59 PM
Humidity Min Time	2/22/2010 2:38:15 PM
Dust Average	15.585 mg/m <sup>3</sup>
Dust Min	0.072 mg/m <sup>3</sup>
Dust Max	66.812 mg/m <sup>3</sup>
Dust TWA	0.064 mg/m <sup>3</sup>
Dust Min Time	2/22/2010 2:38:52 PM
Dust Max Time	2/22/2010 2:37:13 PM
CO2Ave	706 PPM
CO2Min	633 PPM
CO2Max	795 PPM

Figure 5-2: Sample summary data from a DMS table

## Logged Data/Time History

Logged data, also referred to as “time history,” plots measurements with a specified logging interval ranging from 1 second intervals to 60 minute intervals (as set up in the EVM monitors via the logging screen).

Time History data represents measurements that occurred over the most recent time period, which is the logging interval. For example, if the log interval is 1 minute, then the maximum value is the highest value for that 1 minute, and the Lavg value is the average value for that 1 minute.

**NOTE:** DMS has two default logged data charts that appear: temperature and humidity on the first logged chart, and Dust and CO<sub>2</sub> data on the second logged data chart. (If you do not have those sensors installed, they will not appear.) In DMS, to view different sensor measurement parameters on the logged data chart, click on the  and click in the specific sensors' checkboxes.

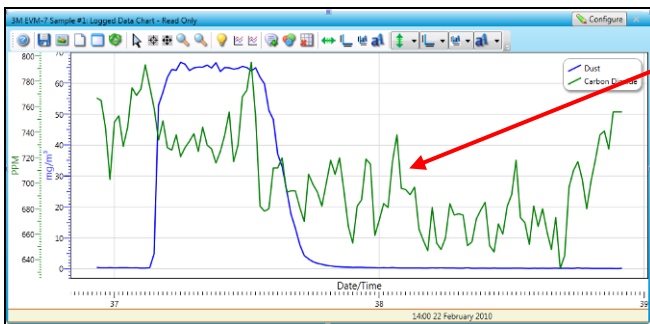



Figure 5-3: Sample time history data (or logged data) chart

## Running and Stopping

When running a session, the pump will automatically turn on during your logging/run if particulate is enabled. (This is explained in the Particulate setup section.) At any time, you can turn the pump off (disable) if you are not measuring particulates or the environment is extremely dirty and you want to keep the pump clean. Simply press the particulate key (as indicated in Figure 2-2) to turn this feature off. To page through the measurement screens, press **◀/▶ Arrows**.

**NOTE:** For particulates ensure the impactor is well-greased before measuring (see [“Impactor Care”](#) for details).

### ➤ Running and Stopping measurements

- From the start screen or any of the measurement screens, press the **Run/Stop**  key to begin measuring.
  - A 5 second countdown will appear with a run message (in pause mode) when the particulate setting is enabled.
- Press and hold the **Run/Stop**  key to stop measuring.

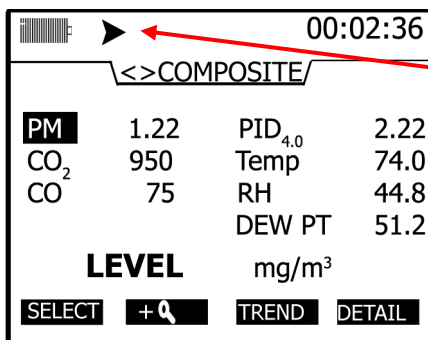

Run mode

Level values for each sensor

**Shortcut:** Press Enter key to toggle through different measurement units.

Figure 5-4: Composite measurement screen in run mode

## Measurement Screens and Navigation

To navigate through the measurement screens repeatedly press ◀/▶ **Arrows** key from the **Start** screen. (The start screen is the second screen you encounter after the initial splash screen.

Looking at the measurement screens clockwise (or pressing ▶ **Arrow** key), you will see the particulate measurement screen. The subsequent screens that appear include the relative humidity and temperature screen, the gas screen, the composite screen, and the air velocity screen. Depending upon the sensors you purchased, the installed sensors, and the measurement setup you may see some variations in the upcoming measurement screens in comparison to your instrument. These will be noted (or explained in full detail).

## Unit defined

While viewing your measurement data, you will want to have a good understanding of the abbreviated units used on the instrument. These are listed in Table 5-1.

Abbreviations on the EVM	Explanation
OL	<b>Over Load</b> – This indicates a measurement (on the current screen) is above the maximum value (for that sensor) which the instrument can measure.
UR	<b>Under Range</b> – A measurement (on the current screen) is below the minimum value (for that sensor) which the instrument can measure.
°F	<b>Degrees Fahrenheit</b> – This is displayed with readings for Temperature and Dew Point.
°C	<b>Degrees Celsius</b> – This is displayed with readings for Temperature and Dew Point.
%	<b>Percent</b> - This is displayed for the percentage measurement for the pump flow rate, the relative humidity sensor, and the Oxygen sensor.
ppm	<b>Parts per Million</b> – This is displayed with measurement readings of CO <sub>2</sub> , toxic gas, and PID sensor (for VOCs).
ppb	<b>Parts per Billion</b> – This is displayed with reading of PID sensor (for VOCs).
mg/m <sup>3</sup>	<b>Milligrams per cubic meter</b> – This is a unit of measurement (of mass per unit volume) and is used for particulate measurements and PID PPM (PID sensor for VOCs).
µg/m <sup>3</sup>	<b>Micrograms per cubic meter</b> – This is a unit of measurement (of mass per unit volume) and is used for particulate measurements and PID PPB (PID sensor for VOCs).
m <sup>3</sup>	<b>Volume</b> – Gravimetric volume for the particulate measurements.
mg	<b>Mass in Milligrams</b> – Gravimetric accumulator mass for the collected particulates.
m/s	<b>Meters per second</b> – This is the unit of measurement for metric air velocity.
ft/m	<b>Feet per minute</b> – This is the unit of measurement for air velocity.

Table 5-1: Unit abbreviations

## About the Measurement Soft Keys

Each measurement screen has soft keys (extended menus) which are used to view different measurements.

☑ **NOTE:** Press the **Enter** key to toggle through the various measurements.)

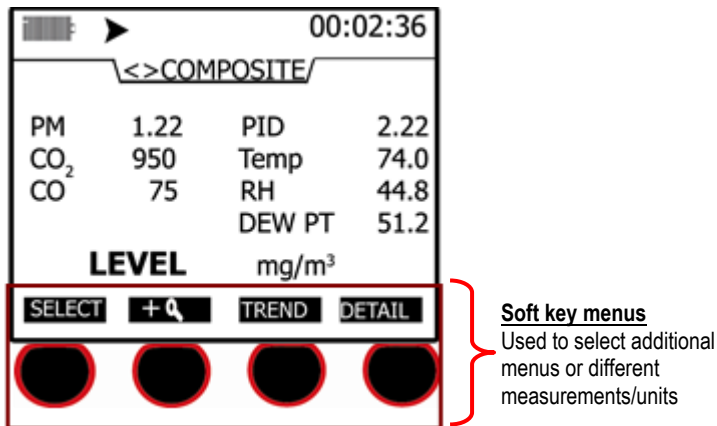

Figure 5-5: Example of measurement soft key menu



Measurement Soft keys	Explanation
<b>Lookup soft key (eyeglasses)</b> 	<b>Lookup icon (eyeglasses) soft key</b> – used to select and view different measurement values (on the particulate and air velocity screens). Level, Maximum, Minimum, Average, Short Term Exposure Level (STEL) and Time Weighted Average (TWA).
<b>Select soft key</b> 	<b>Select soft key</b> - if more than one sensor/parameter is selectable on a measurement screen, this is used to select a sensor such as: temperature, toxic gas sensor, PID sensor etc. If you are on the composite screen and the screen is magnified, you can select each sensor and the measurement units will be displayed on the bottom of the screen.
+/- 	<b>Magnifying glass symbol</b> – Used to Zoom in (+) or out (-). (The plus denotes zoomed in and the minus sign denotes zoomed out.)
<b>Detail soft key</b>	<b>Detail soft key</b> – used to view a sensor’s measurement values in a summary screen. For example, if you are on the composite measurement screen and you want to view the summary data for CO <sub>2</sub> , you would first select the CO <sub>2</sub> field and then select the Detail soft key. You may need to press the up/down arrow to scroll through the data.
<b>Trend soft key</b>	<b>Trend soft key</b> – is graphical chart and is used to give you a quick synopsis of trends over time such as a high volume of particulates at a specific time. The following settings are always logged and are viewable by pressing the <b>Alt</b> key when you are viewing the trend screen: 90 sec, 180 sec, 900 sec, 90 min, 3 hrs, 8 hrs, 12 hrs, 24 hrs. The timescale (x-axis) can be expanded by pressing the right or left arrow keys. The measurement level (y-axis) can be expanded and contracted (some sensors) by pressing the up or down arrow keys.

Table 5-2: Measurement soft keys explained

## Particulate Measurement Screen

The particulate measurement screen displays the user-adjustable impactor setting (i.e., PM 2.5), the applied profile (or correction factor) and various measurements (level, max, min, etc.)

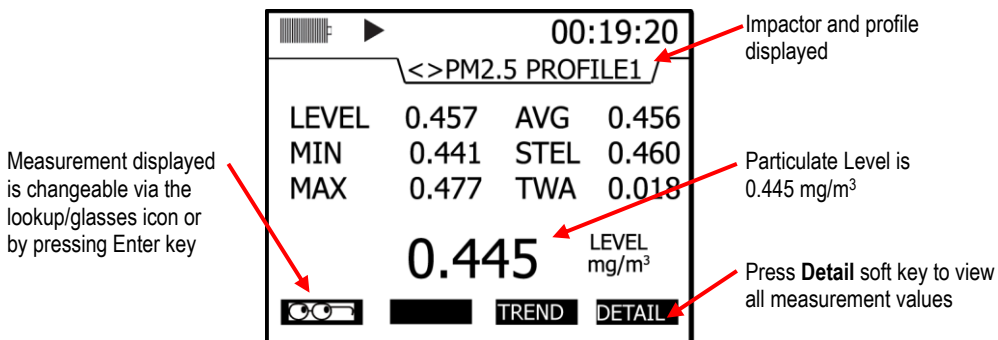

Figure 5-6: Particulate Measurement screen

## Impactors and Particulate Measuring

As discussed in the calibration chapter, there are four selectable particulate settings. To move the impactor, ensure you are in stop mode. Then, twist to the right or left until you feel a tactile detent. The impactor setting will align to the gray marking on the housing (see Figure 4-4 for an example).

- ☑ **NOTE:** The particulate screen will display "ERR" if it is not clicked into one of the appropriate settings. The selections include: PM2.5, PM4, PM10, and PM.
- ☑ **NOTE:** The impactors may require cleaning during or after your measurement study. Please see [Chapter 4](#), "Impactor and Use" for more information.

## Extending Run-Time for PM Measurements

If you will be measuring in a dusty environment (such as an environment that is oily) or for a long period of time (10+ hours), you may need to clean the impactors frequently in order to remove the debris build-up on the impactor. (See [Chapter 7](#) for Maintenance and cleaning for more detailed instructions.)

To extend the run-time for PM measurements, attach a cyclone to the turret. The cyclone is used to prevent the larger dust particles from building-up on the impactor which eventually clogs the impactor. It forces the larger particulates, using centrifugal force, down and around the filter and collects in the bottom holding cap. (See Figure 4-6 for more details.)

- ☑ **NOTE:** You use a cyclone that is designed to work at 1.67 L/min pump flow rate.

## Changing Particulate Measurements

To change the displayed measurements, there are three options in the particulate screen. You can press the Enter (↵) key to page through each measurement, select a specific measurement from the lookup/glasses soft key, and/or press the **Detail** soft key. (The measurements are defined in Table 5-3).

☑ **NOTE:** If “---” characters appear on the screen, this denotes that the measurement is invalid.

### ➤ To change your measurement view

1. Click on the “**Look-up**” icon (👓).
2. In the pop-up measurement menu press the **Up/Down** arrow to select a different type.
3. Press **Enter** (↵) to select. On the particulate screen, the selected measurement type will appear.
4. To view a graphical view of the data, press the **Trend** soft key. In the Trend screen, press the **Line** soft key. This switches the screen from a dotted line to a shaded bar chart view. To exit this screen, press **On/Off/Esc** (⏻).

☑ **NOTE:** Press the **Alt** key to toggle between the trend time scale and the soft keys.

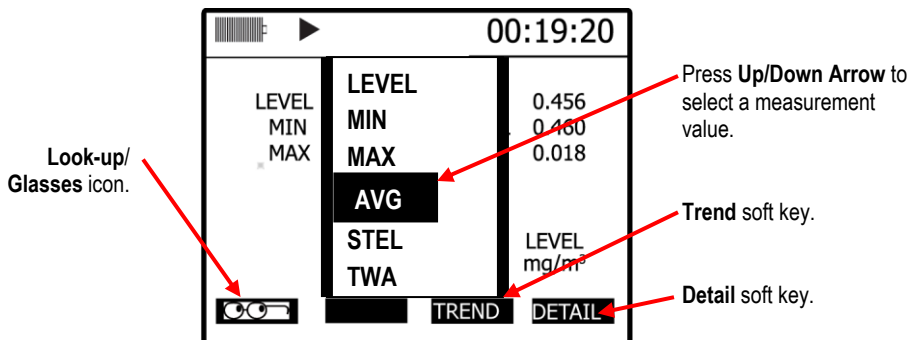



Figure 5-7: Selecting a measurement calculation

- Or select the **Detail** soft key and a summary of all the measurements will appear. (Below is an explanation of measurements.)

Measurement values	Explanation
<b>LEVEL</b>	<b>Level</b> - Notation used to represent current live reading of the sensor. (This is updated once a second.)
<b>MIN</b>	<b>Minimum</b> - Minimum level value which occurred during a log session.
<b>MAX</b>	<b>Maximum</b> - Maximum level value which occurred during a log session.
<b>AVG</b>	<b>Average</b> - Arithmetic average of all level values which occurred during a log session.
<b>STEL</b>	<b>Short term exposure level</b> - is a calculation used to indicate an exposure level (to a toxin) over a short-term period. This value is calculated by averaging the last 15 one minute averages. This value is invalid for the first 15 minutes and is updated every minute thereafter. Essentially, it is used when the building occupant/worker is exposed to high concentrations of chemical gases. The measurement will average after 15 minutes of data logging and continue to compute after each minute of logging, using measurements from the most recent fifteen minutes. If less than 15 minutes has elapsed, the STEL will be invalid by displaying dashes.
<b>TWA</b>	<b>Time weighted average</b> - is an average based on an 8-hour interval. The summing all of the level values taken and dividing by the number of samples in 8 hours (at one sample per second the total would be 28,800). The important thing here is that the average is calculated the same way regardless of whether you've run the instrument for 1 hour, 8 hours, 24 hours or any other amount of time (i.e. the number of samples used to divide by is the same). This value is updated once a second.

Table 5-3: Measurement values explained

## Relative Humidity and Temperature Measurements

The relative humidity and temperature sensor will display on the left-hand side of the screen with two measurement values. The measurement displayed in the second column is user-selectable via Enter .

### Relative Humidity and Temperature Screen

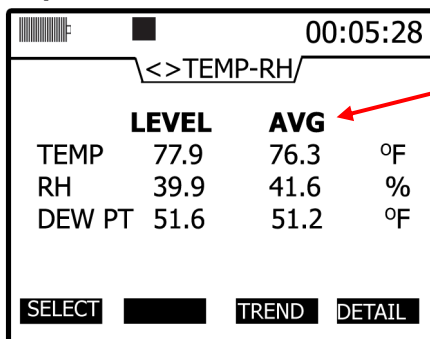

To select a different measurement type, press the **Enter** key repeatedly.

**Select, Trend, Detail** soft keys (used to change the measurement view).

Figure 5-8: RH and temperature measurement screen



➤ **To change the RH and Temperature measurement view**

1. Press the **Select** soft key, **Trend** soft key, or the **Detail** soft key. (See Table 5-1 for details).  
☑ **NOTE:** The ▲/▼ **Arrows** can be used instead of the **Select** soft key.

## Gas Measurements

The gas measurement screen displays the measurements for CO<sub>2</sub>, toxic gas(es), and PID sensor.

- ☑ **NOTE:** Depending on what sensors you ordered and which sensors are installed, the appropriate gas sensors will display on this screen.

## Gas Screen

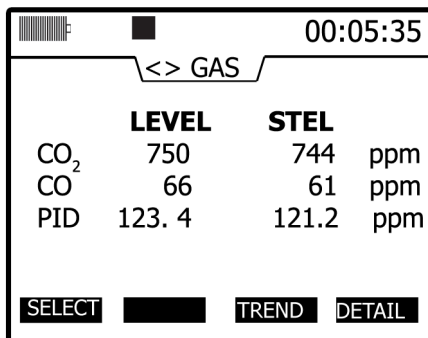

Figure 5-9: Gas measurement screen





➤ **To change the gas measurements view**

1. Press the **Select** soft key, **Trend** soft key, or the **Detail** soft key. (See “Viewing summary/details” or “Viewing trend details.”)  
☑ **NOTE:** The ▲/▼ **Arrows** can be used instead of the **Select** soft key.

## Composite Measurement

When you first access the composite screen, all of the sensors appear on the screen. There are two main views which is dependent on if you pressed the zoomed-in or zoomed-out soft key. (The “zoomed-out” is the default composite view.)

### Composite Screens

+		<b>Zoomed in:</b> The composite measurement screen (when zoomed-in) combines all sensors/parameters into one screen with two columns displaying two different measurement calculations. The second column is changeable by pressing <b>Enter</b>  . (See “B” below.)
-		<b>Zoomed out:</b> The composite measurement screen (when zoomed-out), appears with the measurements for all installed sensors. Press <b>Enter</b>  to change the measurement values (as explained in Table 5-3). Press <b>▲/▼ Arrows</b> or <b>Enter</b>  to page through sensors. (See “A” below.)

**A- Zoomed -out (Magnify soft key)**

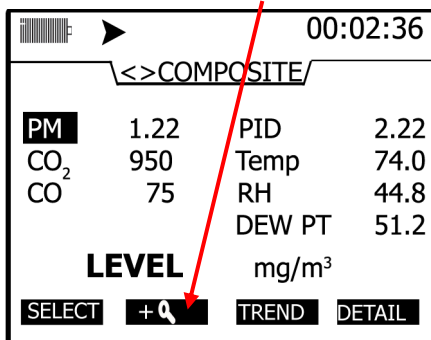

**B – Zoomed-in (Magnify soft key)**

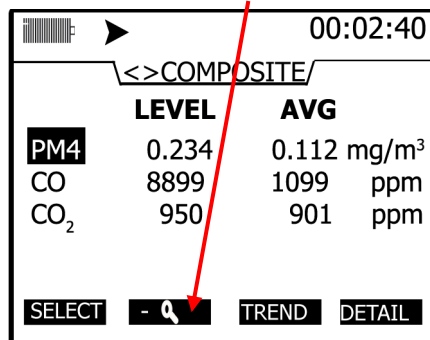

Figure 5-10: Composite measurement screen

➤ **To change the composite measurements/view**

1. Press the **Select** soft key, **Trend** soft key, or the **Detail** soft key (see “Viewing summary/details” or “Viewing trend data” for more details).
  2. To zoom in on the results, press the **Magnify** soft key (see “B”).

## Air Velocity Measurement Screen

There are a couple quick steps to ensure air velocity is setup and that the Air Probe is attached before measuring.

1. The air velocity setting is enabled in **Setup /AUX/Air Velocity** screen (see “Air Velocity” Setup in [Chapter 3](#) for more details).
2. Connect the Air Probe bracket attachment to the backside of the EVM. Attach the Air Probe to the bracket. Next, plug in Air Probe plug from the Air Probe to the digital output on the instrument. (See Air Probe output below.)  
 **NOTE:** It is optional to attach the Air Probe to the bracket on the instrument.
3. Turn Air Probe switch to **On**.
4. Navigate to the Air Velocity measurement screen using the **◀/▶ Arrows**.
5. To log air velocity data, press the **Run/Stop** key.



Figure 5-11: Attaching Air Probe and measuring Air velocity

## Summary Data

In each of the measurement screens, a Detail soft key will appear. Once selected, you can view a quick summary of all measurement calculations in one screen. This is explained below.

### Viewing Details in the Measurement Screen

- **Viewing the composite measurements in individual summary screens**
- 1. To view details of a sensor, select a measurement screen and then select/highlight a specific sensor (if more than one is displayed).
  - For example, to select PM from the **Composite** screen, press ▲/▼ **Arrows** or the **Select** soft key.
- 2. Press the **Detail** soft key and a summary screen of the selected measurement screen (i.e., PM 2.5 – particulates screen) will appear.

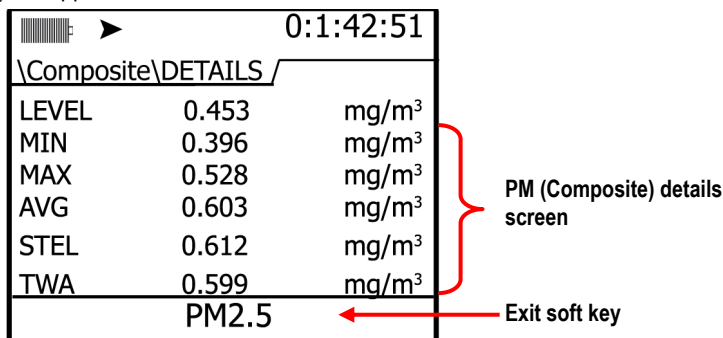



Figure 5-12: Details of the composite measurement screen

- 3. Press **On/Off/Esc**  to return to the previous screen.
  - Repeat these steps to view other sensor measurements.

## Trend Data

The trend data screen is a graphical logged data chart and is viewable in all the measurement screens. Depending on the parameter you are viewing (i.e., PID sensor, Particulates, etc...), it will display the measurement level values in a graphical format.

### Viewing trend data in the measurement screen

The example in Figure 5-13 displays particulate trend data with one second level values.

#### ➤ Trend data screen

1. To select a trend screen, first select a measurement screen you want to view.

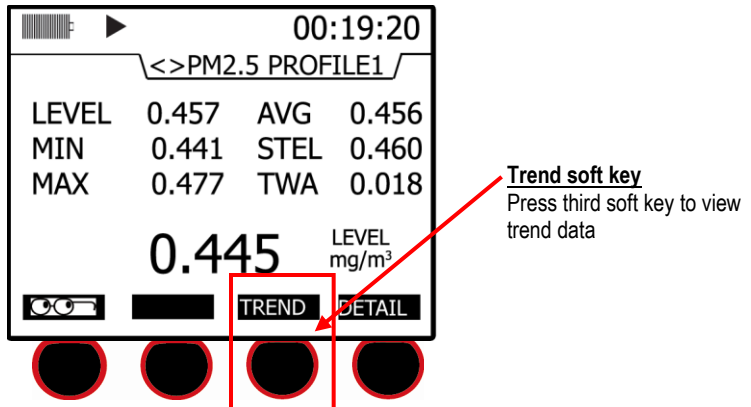

Figure 5-13: Selecting Trend soft key

2. In the measurement screen, press the **Trend soft key** and a graphical data chart will appear.
  - You can either view the data as a “Line” format or a “Bar” chart format by pressing these soft keys on the bottom of the display.
3. (Optional) Press the **Alt** key to toggle between the trend time scale units and the soft key menu.
4. (Optional) Press **▲/▼ Arrows** to change the vertical range.

5. (Optional) Press ◀/▶ **Arrows** to change the horizontal range.

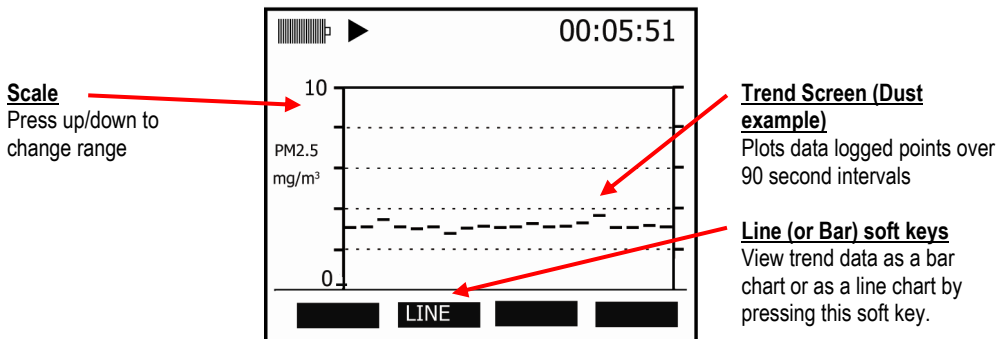

Figure 5-14: Trend Screen for PM (Dust)

6. Press **On/Off/Esc**  to return to previous screen.

## Past Session

The past session summary screen allows you to view your session summary data. You can view sessions by name and file size, name and date, or name and run time via the lookup soft key. Once a session is selected, the measurement summary information is viewable and selectable via ◀/▶ **Arrows**.

☑ **NOTE:** The session run time will appear at the top of display.

## Summary Data Screen

### ➤ Selecting and viewing past session summary data

1. From the **Start** screen, select past session summary menu and press **Enter** .
2. In the past session screen, to view the last session, ensure this field is selected then press **Detail** soft key.

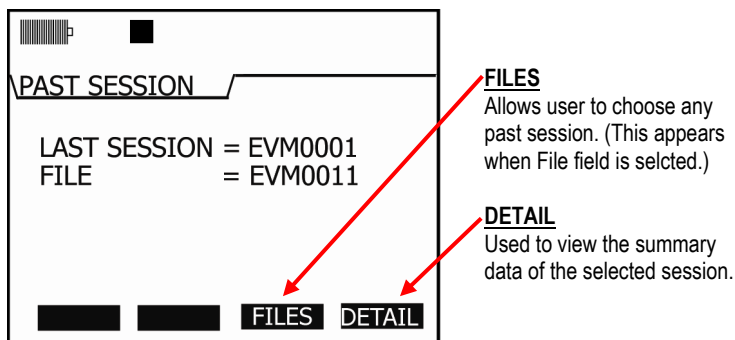

Figure 5-15: Past session screen

3. To select a specific file, first select the **File** field and then press the **Files soft key** and the **Load File** screen will appear.
  - **Optional:** press the **Look-up** soft key to view the file by name and file size, name and date, or name and run time. To select, press **up/down arrow** and then press the **Load** soft key to select.
  - ☑ **NOTE:** Pressing the **Enter** key will sequence the files size, date, and run time.
  - To select a session, press **▲ /▼ Arrows** and press the **Load** soft key.

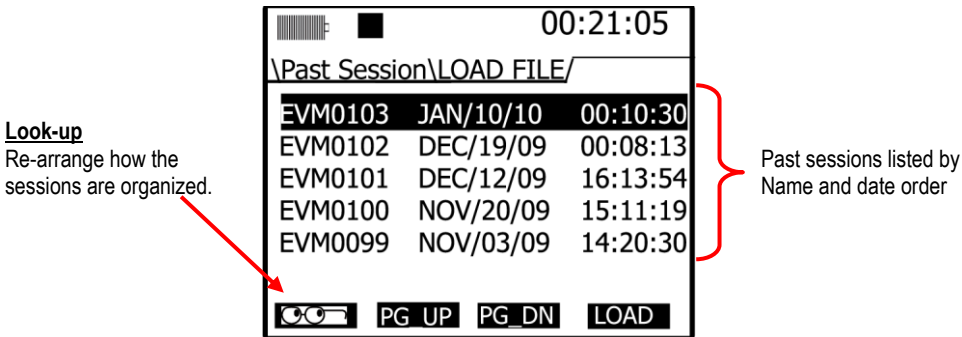

Figure 5-16: Past Session with Files selected

Files soft keys	Explanation
<b>Lookup</b>	Look-up soft key: used to organize the session files by the following: Name & file size, Name &date, or Name& run time
<b>PG-UP</b>	Displays the previous page of session files.
<b>PG-DN</b>	Displays the next page of session files.
<b>LOAD</b>	Once you select a session file to view, press the Load soft key in order to LOAD and then view the detailed summary data screens.

Table 5-4: Past session files soft keys explained

4. Once a file is selected and loaded, press the **Detail** soft key to view the summary data.
  - ☑ **NOTE:** The particulates, toxic gas, CO<sub>2</sub> gas, and PID sensors will detail the following measurement parameters: Min, Max, Avg, Max STEL, TWA. For RH, Temp, and Air Velocity, the measurement parameters include: Max, Min, and Avg.

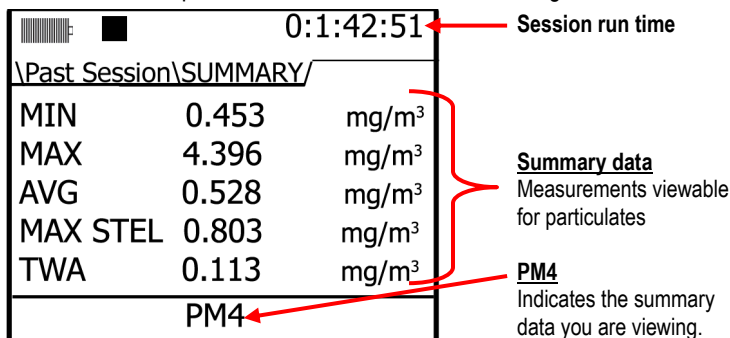



Figure 5-17: Summary screen of a past session

5. When viewing summary data, press **◀/▶ Arrows** to view summary data for each sensor. (This is similar to viewing measurements during run or stop mode.)
  - In the summary data screen, the session run time will appear in the upper hand corner of the display.
  - ☑ **NOTE:** For particulates summary data, it will display the impactor setting applied during the measurement (i.e., PM4).
6. To return to the main screen, press **On/Off/Esc**  twice to return to the **Start** screen.

## File System Menu

With the File system menu, you can delete or clear sessions one-by-one or delete all sessions. You can also verify the used and free memory of the instrument via the Properties menu. The instructions below explain the Session Directory menu, Delete All Session menu, and the File System Properties menu.

### Deleting Sessions Individually

- **Deleting sessions individually**
1. Open the **File System** screen from the **Start** menu and select the **Session Directory** menu. Then, press **Enter**  to open.
  2. In the **File System/Sessions** screen, you have the same soft key selections as the **Past Session Summary** menu. (See Table 5-4 for soft key explanation.)
  3. To delete a selected session, first select a specific session to delete by pressing the **▲/▼ Arrows**.



4. Press the **Delete** soft key. A **Delete** pop-up screen will appear. To confirm the delete, press the **Left** arrow and then press the **Enter** . (This will delete the selected session.)

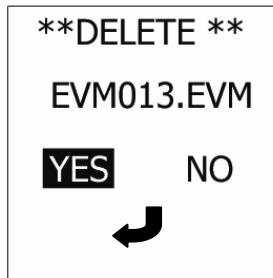

**Delete message**  
Press left/right arrow to select "Yes" or "No". Then press **Enter** key.



Figure 5-18: Delete session message

5. Repeat these steps until all of the appropriate sessions are deleted (or see the next section, "Delete All" to delete all of the sessions.)

## Delete All Sessions

Once you have reviewed your data and possibly downloaded to DMS for future storage, you can delete all sessions.

### ➤ Deleting all sessions

1. Open the **File System** screen from the **Start** menu and select the **Delete All Sessions** menu. Then, press **Enter**  to open.
2. A delete message will appear. Press the **left arrow** to select **Yes** and press **Enter**  to delete all sessions.

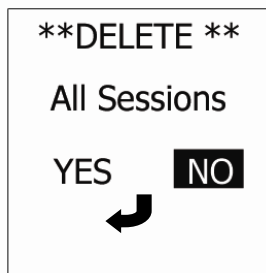

**Delete all sessions message**  
Press left/right arrow to select "Yes" or "No". Then press **Enter** key.

Figure 5-19: Delete all sessions message

3. A message stating "deleted all sessions will appear".
4. To return to the start screen, press **On/Off/Esc** .

## Memory Remaining and File Properties

The properties screen displays the number of stored files, the total amount of space used on the instrument, and the amount of free memory space.

### ➤ Viewing remaining memory and file properties

1. Open the **File System** screen from the **Start** menu and select the **Properties** menu by pressing the **Down** arrow key.
2. Then, press **Enter**  key to open the **Properties** screen.
  - **Num Files field** – indicates the number of files saved on the instrument.
  - **Used field** – indicates the amount of memory used in the instrument's file storage.
  - **Free field** – indicates the amount of memory available (or free) on the instrument.

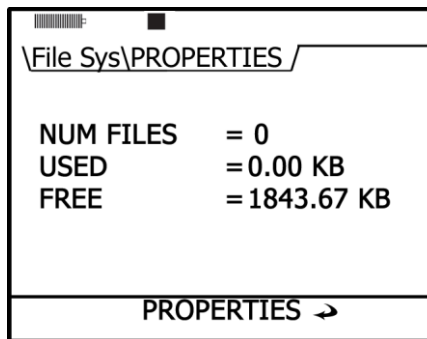

**File system properties**  
Summarizes the memory remaining on the instrument.

Figure 5-20: File Systems properties screen

## Estimated Run Time

The Estimated Run Time screen displays the amount of days, hours, and minutes' remaining on the instrument. You can extend the run time if you log less parameters (such as, only logging MAX or increasing the log interval.)

You may want to download and save your files in DMS and then clear the memory on the EVM. This will also extend the logged time. For more information on estimated run time charts, see [Appendix A](#), "Estimated logged run times."

**NOTE:** The estimated run time screen is also viewable via the logging setup screen (for more details, see [Chapter 3](#), "setting logging and viewing runtime").

➤ **View estimated run time**

1. Open the **File System** screen from the **Start** menu and select the **Estimated Run Time** menu by repeatedly pressing the **Down** arrow key.
2. Then, press **Enter**  key and the **Estimated Run Time** screen will appear.

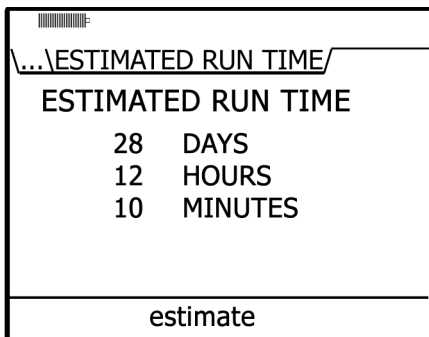

Figure 5-21: Viewing estimated run time

*(This page intentionally left blank)*



# Detection Management Software

## Environmental Monitor Communication

Once communicating with the Environmental Monitor (EVM) and Detection Management Software (DMS), you have the option to download data, configure instrument parameters, and configure quick setup features, such as the time and date settings. The following explains the EVM communication download and/or setup steps.

1. Plug the USB cable into the powered on EVM and then connect it to the computer port.



**Figure 6: Communicating with the Environmental Monitor and Detection Management Software**

- From the start page of DMS, select either **Setup** button (see 1) or **Download** button (see 2) and the **Instrument Communications** page will appear with setup and download panels.
- Select **Air Quality** and then select **EVM** under **Instrument** (see 3 and 4). You are now ready to setup or download your instrument (see 5).

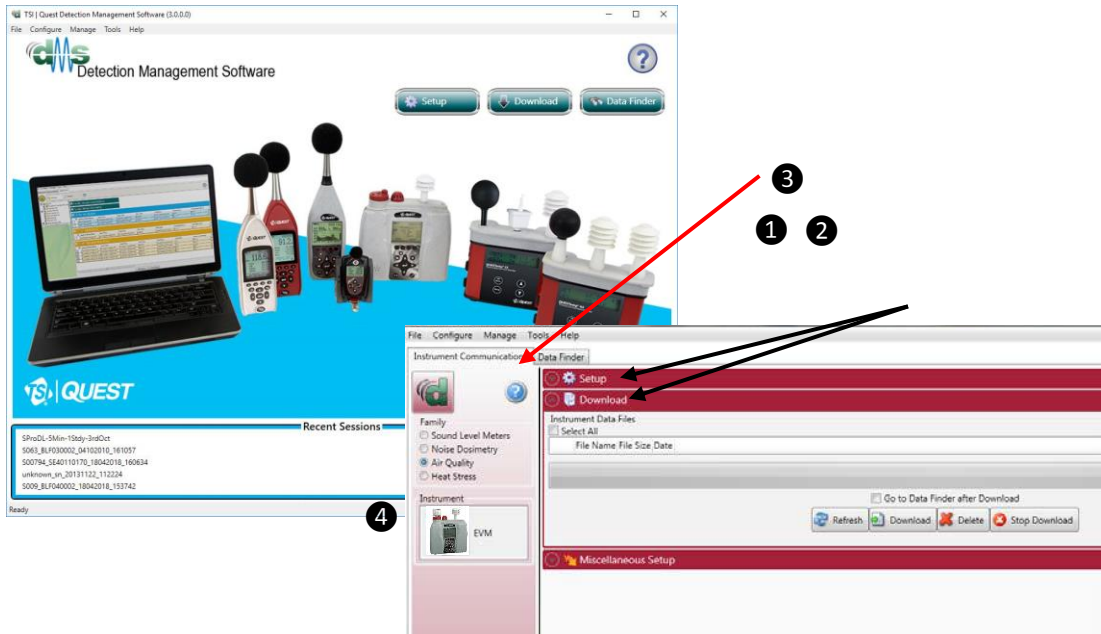



Figure 6-1: DMS Start page and Setup/Download options

## Downloading Data with the EVM

The Instrument Download feature enables you to download your files from the EVM Series into the software for review and analysis of the data. Once the files are downloaded and if “Go to Session Finder after Download” is checked, DMS will open into the session finder page. To download, follow the steps below:

1. To download the EVM data, ensure your instrument is communicating properly. (See communication setup for details.)
2. From the **Start** page, select the  button.
3. Select the **Air Quality** family and the EVM from the Instrument window (see **1**).
4. Press the **Download** button (see **2**).

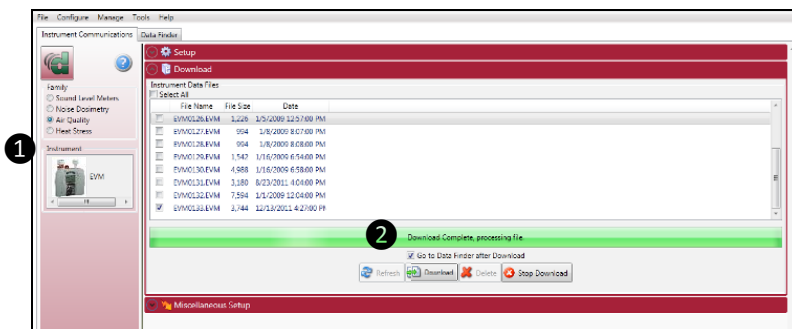



Figure 6-2: EVM and downloading

## EVM: Viewing Data

The data finder page, displayed below, is used to view, select, analyze, and create reports after the data is downloaded. . The data is presented in a bar chart style with measurements/parameters displayed on the top navigational bar by family.

## Selecting a session/study

To view downloaded data from the welcome page, click on the  button and the data finder screen will appear. (Or select the **Data Finder** tab if already opened.)

1. Select a session by either double-clicking on data or click on the session/study and select the  button.
  - **Family: Air Quality:** EVM data is stored in this family (see **1**).
  - **Session/Study:** The EVM data is organized by the table headings, such as the session/study name (see **2**).
  - **Start Time:** To quickly locate your study by most recent start time, click on the **Start Time** heading and it will sort ascending/descending (see **3**).
  - **Analyze/Report:** Select a session and then click on one of the buttons (see **4**).

The screenshot shows the 'Data Finder' window in the EVM software. The window title is 'EVM0123\_LAURAS E...'. The left sidebar shows a tree view of data categories: Data (231), Sample Data, Air Quality (2), Heat Stress (1), Noise (3), and Sensing Data (1). The main area displays a table of data for the 'Family: Air Quality' category. The table has columns for Session/Study Name, Start Time, Stop Time, Run Time, Dust Average-1, Dust Max-1, CO2 Average-1, Carbon Dioxide Min-1, and Temperature. The data is sorted by Run Time. Callouts 1-4 are placed on the interface: 1 points to the 'Sample Data' checkbox, 2 points to the 'Data' folder, 3 points to the 'Family: Air Quality' header, and 4 points to the 'Dust Average-1' column.

Session/Study Name	Start Time	Stop Time	Run Time	Dust Average-1	Dust Max-1	CO2 Average-1	Carbon Dioxide Min-1	Temperature
EVM0123_LAURAS EVM_13	12/13/2011 4:25:50 PM	12/13/2011 4:27:13 PM	000123	0.3 mg/m <sup>3</sup>	2.2 mg/m <sup>3</sup>	774.9 PPM	0 PPM	21.3 °C
EVM0123_LAURAS EVM_13	2/22/2011 2:25:55 PM	2/22/2011 2:26:06 PM	000011	0.3 mg/m <sup>3</sup>	1.6 mg/m <sup>3</sup>	2000 PPM	2000 PPM	24 °C
EVM0123_LAURAS EVM_22	2/22/2011 2:25:55 PM	2/22/2011 2:26:06 PM	000011	0.3 mg/m <sup>3</sup>	1.6 mg/m <sup>3</sup>	2000 PPM	2000 PPM	24 °C
EVM0123_LAURAS EVM_13	12/13/2011 4:25:50 PM	12/13/2011 4:27:13 PM	000123	0.3 mg/m <sup>3</sup>	2.2 mg/m <sup>3</sup>	774.9 PPM	0 PPM	21.3 °C
EVM0123_LAURAS EVM_22	2/22/2011 2:25:55 PM	2/22/2011 2:26:06 PM	000011	0.3 mg/m <sup>3</sup>	1.6 mg/m <sup>3</sup>	2000 PPM	2000 PPM	24 °C

Figure 6-3: Data finder page

## EVM Panel Layout View (PLV) Page

The measurements and parameters will be displayed in charts and graphs which may be customized for analysis and/or reporting purposes.

**NOTE:** A  button provides a quick link to viewing the panel layout view data in a report format.

- The PLV page is divided into Work Items (see ①), Add panel (see ②), Arrange Panels (see ③) and Data Panels (see ④).

- Work items (①)** – select either the session or study (in order to view appropriate measurement/parameter data).
- Add panel (②)** – double-click on a chart/table type and it will appear as a panel on your screen.
- Arrange panels (③)** – displays the order of the sessions/studies displayed in the panel section of your screen.
- Data Panels (④)** – used to view your measurement and/or parameters from your study.

**NOTE:** Use the menu bar icons and/or configure icon to customize parameters.

- Toolbar and Configure button (⑤)** – used to customize or select different measurement parameters.



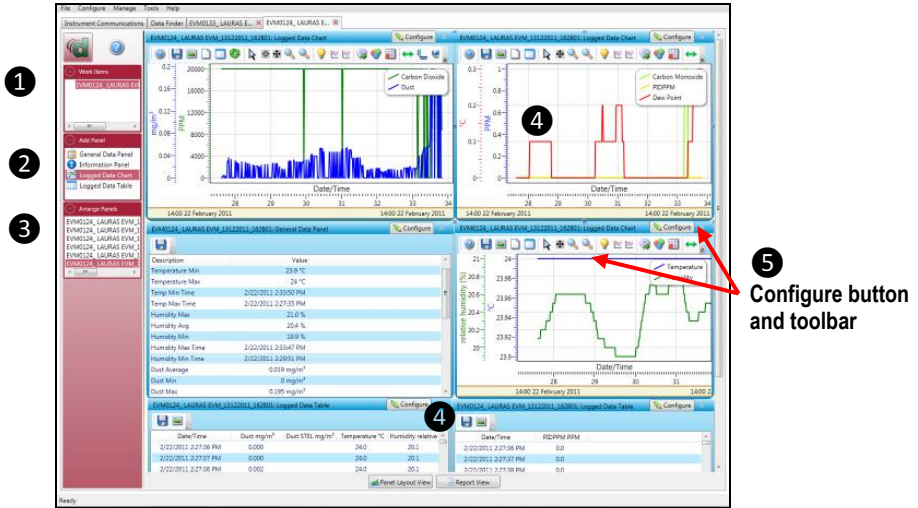
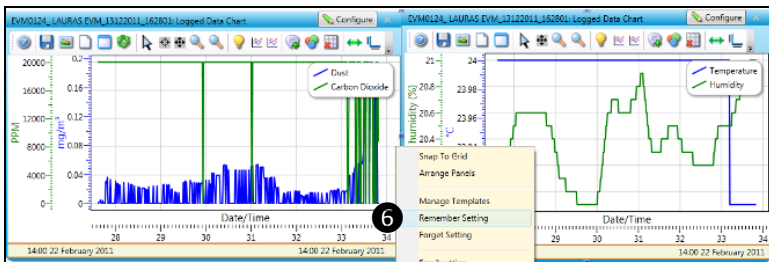



Figure 6-4: Charts and Graphs (panels)

2. To change the graph/table data parameters, click on the **Configure** button. Each graph/table may have different configurable parameters depending on the parameters applicable to the specific panel.
3. To view the data as a report, click the **Report View** button (see **6**).
  - NOTE:** The panels will print in the order in which they are displayed in the panel layout page.
4. The quick tips below explain how to customize the panels and/or graphs/tables:
  - **To stretch the graph/tables**, click on one the corner's edge of a chart or table and drag the mouse. The graph/table will expand or shrink when resizing.
  - **To move the graph**, click, drag and drop to the appropriate panel position.
  - **To change ranges**, when clicking on either the x-axis or y-axis, click and drag the mouse until the appropriate range is selected.
    - NOTE:** It will span the numbers up or down depending on how you drag the mouse.
  - To save a layout, Right-click outside the tables/graphs area as displayed below. Click **Remember Setting** (see **6**).



## EVM Reports and Printing

To quickly create reports, open your data (in the data finder page) and click the quick report button. A standard template of charts and graphs (or panels) will appear in the report.

- ☑ **NOTE:** The charts/graphs will appear in the order displayed in the panel layout page.
- **Viewing reports:** if you are in the data layout page and you have rearranged the charts/tables, the report will print in the sequence in which they appear on the screen.
- **Printing reports:** while in the report view page you have two options outlined below:
  - Click on the  icon from the title bar.
  - Click on the  icon from the session report title bar.

Report example with logged data chart displayed with EVM data

Customize the report by inserting on-site testing images

Customize the report by inserting on-site testing images via the **Add or Update Customizations...** button.

Description	Value	Description	Value
Temp Avg	24.5 °C	Temperature Min	1.79/2010
Temperature Max	38.4 °C	Temp Min Time	1.79/2010 7:20:42 PM
Temp Max Time	1.15/2010 10:15:07 PM	Humidity Max	44.7 %
Humidity Avg	28.6 %	Humidity Min	20.0 %
Humidity Max Time	1.17/2010 7:20:42 PM	Humidity Min Time	1.17/2010 10:15:09 PM
Dust Average	0.947 mg/m <sup>3</sup>	Dust Min	0 mg/m <sup>3</sup>
Dust Max	2.944 mg/m <sup>3</sup>	Dust STC	0.124 mg/m <sup>3</sup>
Dust Peak	0.077 mg/m <sup>3</sup>	Dust Min Time	1.15/2010 9:06:05 PM
Dust Max Time	1.15/2010	Dust Max STEL Time	1.15/2010

Figure 6-5: EVM data in a report format

## Customizing Reports

To modify the reports with customized headers, footers, report titles, company logos (etc), the customize report feature may be used.

- From the report creation options box (see 1), click on **Add or Update Customizations...** button.
- There are four windows to modify (if applicable) which include: company information, cover page, report, and headers/footers.
- The example below displays customizing the header and footer.

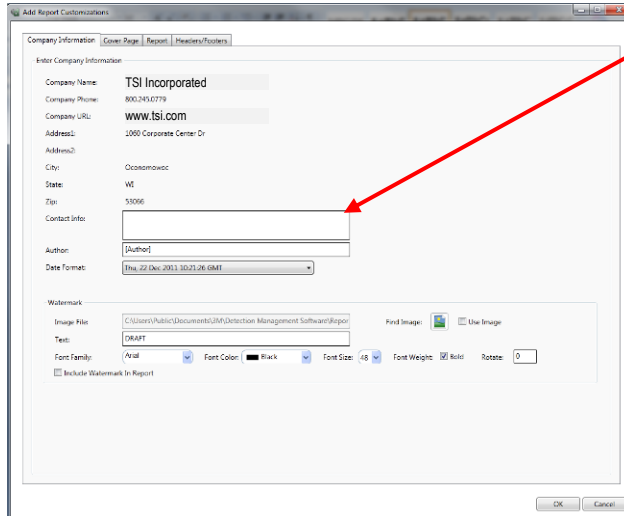
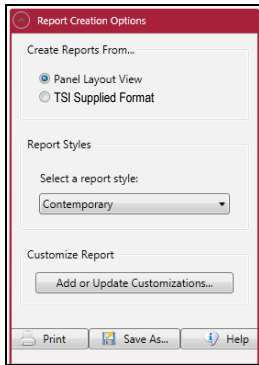

2  
Type in text or use the icons to create customized heading/footer.

To change the TSI logo and add your company's logo, click on the image icon.

Figure 6-6: Customizing DMS reports

## EVM Setup

There are seven configurable EVM setup screens (see ❶ in Figure 6-7 below) in the setup page. With the EVM, you have the option to save the configurations either on the instrument and/or store the configurations in DMS.



☑ **NOTE:** If you save the profiles in the software, this can be used as a time management tool to organize and save all the setups for future use.

Note that there are five different models with different features and functionalities. Some of the setup parameters may not be applicable to your model. Refer to the user manual to understand the models in more detail.

### Saving and Sending Configurations

With the EVM, there are saved setup profiles used to quickly access and apply to your EVM. Below explains how to save configuration settings in DMS and how to send to the instrument.

☑ **NOTE:** To only send the setup, skip to step 3. Refer to this section as you setup your instrument.

1. To save the EVM configuration in the software, click on a name in the **Configuration Profile Management** panel (see ❶). (**Note:** The name will be shaded a light gray when selected.)
  - To create a new profile name, click  and type in a profile name. Click **Save**. (It will save under the configuration profile management panel).
2. Click on the  button (see ❷) and type in a **Name**. Click **Ok**.
  - ☑ **NOTE:** This saves the configuration file to the EVM.
3. To send to the instrument, click on the  (see ❸).

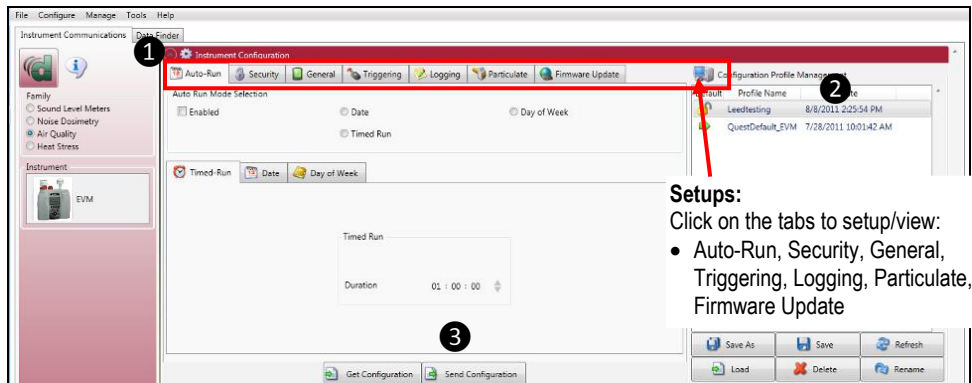

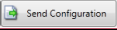

Figure 6-7: Saving and sending EVM setups

## General EVM Setup

The EVM's general settings are used to setup the instrument with basic parameters. Refer to the EVM parameters table below for details.

- Click on the **General** tab from the EVM's Instrument Communications panel (see **1**). To change the general settings, follow one (or all) of the selection options below.
  - Click on the arrow  and select an option.
  - Click on the  arrows and select a numeric value or type in a value.
- To set the general features, click on  or save (see **2**) and **Send Configuration** (see **3**). For more details see "[Saving and sending configurations](#)".

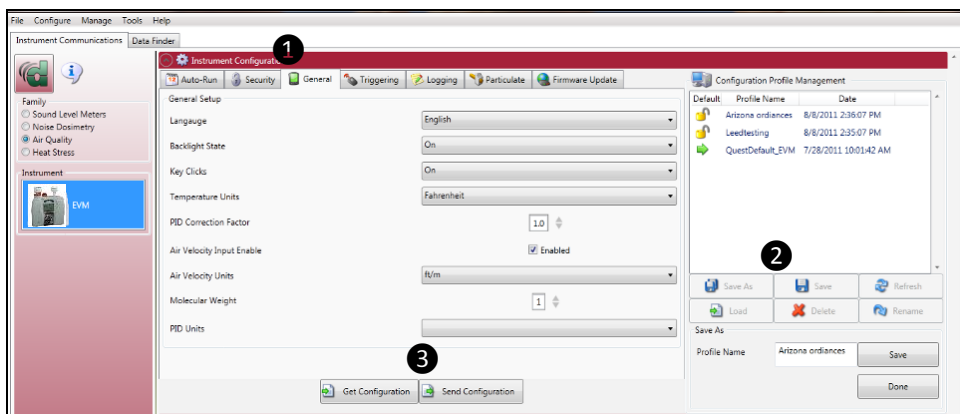

Figure 6-8: General EVM setups

### EVM General Parameters Table

General Parameters	Name Field <b>*Note:</b> Refer to <a href="#">Glossary</a> for more detailed information
Language	With the language setting, there are six options including: English, Spanish, German, French, Italian, and Portuguese.
Backlight State	The backlight is used to illuminate the screen from a dark gray to a light gray color.
Key Clicks	With the key click setting, you can turn the sound to “on” and each time you press a key on the keypad you will hear a soft click sound. This can be disabled by choosing the “off” setting.
Temperature Units	The temperature unit is selectable either in Celsius or Fahrenheit via a drop-down box.
PID Correction Factor	The PID correction factor is automatically set to 1.0. For best results, it is recommended to add a correction factor to the relevant VOC you intend to measure. <b>Note:</b> <a href="#">Appendix C</a> provides a listing of PID correction factors.

General Parameters	Name Field <b>*Note:</b> Refer to <a href="#">Glossary</a> for more detailed information
<b>Air Velocity Input Enable</b>	Air Velocity measurements are conducted with an add-on air velocity probe and can be enabled/disabled in DMS. ( <b>Note:</b> The instrument will automatically detect if the air velocity probe is connected.)
<b>Air Velocity Units</b>	Air velocity units (if enabled and an air probe is connected) is measured in either meters per second (m/s) or feet per minute (ft/m).
<b>Molecular Weight</b>	The default Molecular Weight is programmed to 56 with a correction factor of 1. To change this value either type in a new value or use the up/down arrows.
<b>PID Units</b>	The PID PPM or PPB sensor (for VOC measurements) setting is one of the four: PPM, mg/m <sup>3</sup> , PPB, or µg/m <sup>3</sup> .

## EVM and Logging Settings

The EVM logging screen is used to setup your data logging options. The EVM provides a choice of selectable logging parameters with a specific logging rate (also called logging intervals) and an averaging time. Refer to the Logging table below for an explanation of features.

- Click on the Logging tab (see **1**) from the EVM's Instrument Communications panel. To change the logging settings, follow one (or all) of the selection options below.
  - Click in the  Enabled checkbox to log specific parameters which includes: Levels, STEL, Max, Min, and Avg. (See **2**).
  - Click on the  arrows and select a numeric value or type in a value.
  - Select a Logging rate by clicking on the drop down arrow  and selecting an option from the logging rate list.
- To set the logging settings, click on  or save and send to the EVM (for more details see ["Saving and sending configurations"](#)).

## EVM Logging Parameters Table

Logging Parameters	Name Field *Note: refer to <b>Glossary</b> for more detailed information
<b>Logging setup</b>	<p>To enable logging, click in the specific checkbox to enable one or all of the following measurements:</p> <ul style="list-style-type: none"> <li>• <b>Level:</b> The instantaneous measurement at a specific point in time.</li> <li>• <b>STEL:</b> The maximum concentration above the time-weighted average that employees can be exposed to over a specific time period (usually 15 minutes) no more than four (4) times per day. (See PEL for more information.)</li> <li>• <b>Max:</b> The maximum measurement over the time interval (or logging interval).</li> <li>• <b>Min:</b> The minimum measurement over the time interval (or logging interval).</li> <li>• <b>Avg:</b> The measurement value over the time interval (or logging interval).</li> </ul>
<b>Logging rate</b>	<p>Logging rate/interval (also called time history data) sets the frequency at which data will be logged during a session. The settings include: 1, 5, 15, 30 seconds and 1, 5, 10, 15, 30, and 60 minutes.</p>
<b>Averaging time</b>	<p>A type of data filtering which is applied to the Level measurement. The selectable parameters are 1-30 seconds.</p>

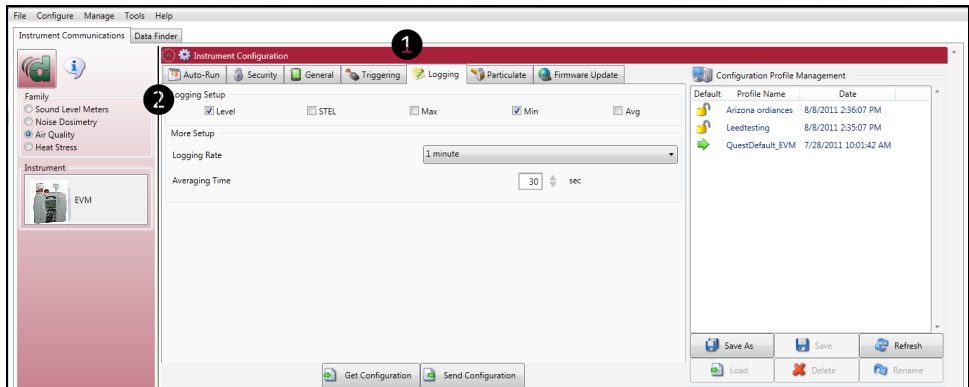

Figure 6-9: Logging EVM setups

## EVM and Auto-Run Setting

The EVM has four programmable auto-run settings including a timed run, a date, a day of week (DOW), and a disabled mode.

The following Auto-Run settings are briefly explained below:

- **Timed-Run mode:** With Timed Run, the EVM is powered on and run is enabled. The EVM will automatically stop based on the programmed duration.

- **Date mode:** With Date mode, With the date mode, it will wake up the instrument from a powered down or on condition, runs the study, saves it, then powers down again. Up to four date settings are programmable with a specified date, time (in hours, minutes, seconds), and duration via the soft keys.
- **Days of week mode:** The days of the week (DOW) setting is a pre-programmed weekly auto-run with a specified day, start time, and duration with two auto on settings. The programmable settings include a day of the week, start time, and duration.

## Timed-Run and Auto-Run Setting

To enable the Timed-Run mode, follow the steps below.

1. Click on the **Auto-Run** tab (see ❶) from the EVM's Instrument Communications panel.
2. Click in the  **Enabled** checkbox and click in the  **Timed-Run** field.
3. Ensure **Timed-Run** tab is selected (see ❷) below and select the Duration by either using the  arrows or type in a duration value.
4. To set the auto-run, click on  or save and send to the EVM (for more details see ["Saving and sending configurations"](#)).

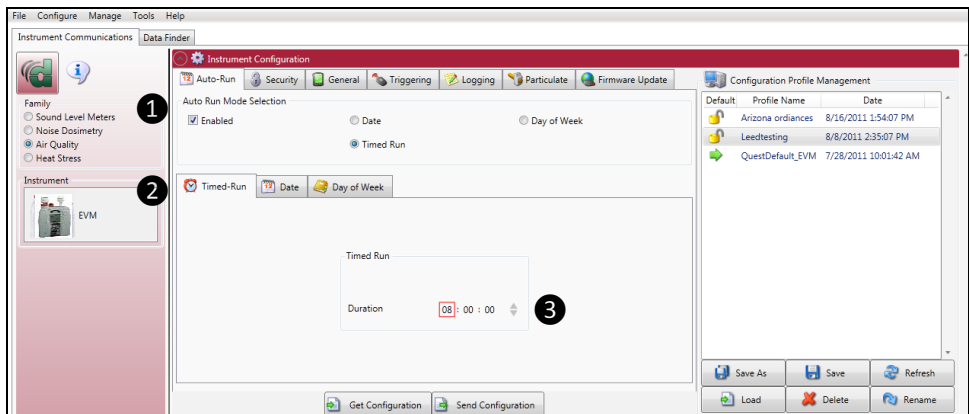



Figure 6-10: EVM Timed-Run Auto-Run setting

## Date and Auto-Run Setting

To enable **Date** mode, follow the steps below.

1. Click on the **Auto-Run** tab (see ❶) from the EVM's Instrument Communications panel.
2. Click in the  **Enabled** checkbox and click in the  **Date** field (See ❷).
3. To enable (or activate) a **Date** setting, click on the **Enabled**  for **Date 1** (See ❸).
  - To set the start date, either use the icon or type in a date value.
  - To set the start time and duration, either use the  arrows or type in a numeric values.
4. To enable additional date settings (Date 2 – Date 4), repeat step 3.



- To set the auto-run, click on  or save and send to the EVM (for more details see [“Saving and sending configurations”](#)).

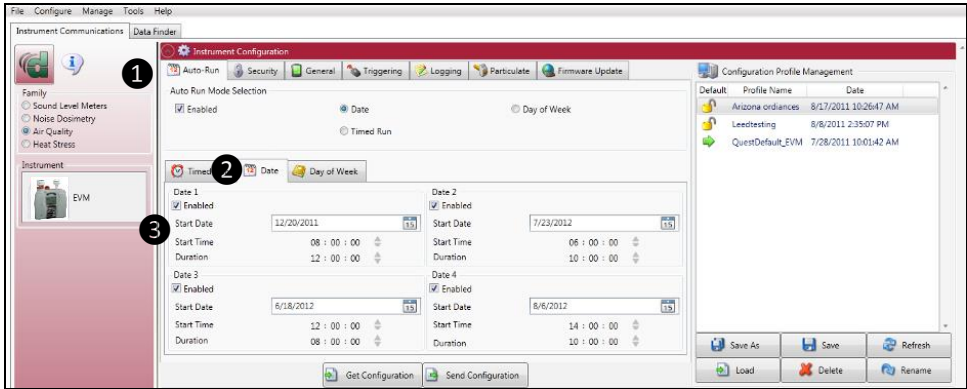
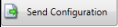

Figure 6-11: EVM Auto-Run with Date setting

### Day of Week and Auto-Run Setting

To enable Date mode, follow the steps below.

- Click on the **Auto-Run** tab (see ❶) from the EVM's Instrument Communications panel.
- Click in the  **Enabled** checkbox and click in the  **Day of Week** field (see ❷).
- To select a day or days click in the appropriate day  boxes.
- To set the **Start Time** and **Duration**, either click on the  or type in numeric value (see ❸).
- To enable **Day of Week 2**, repeat steps 3–4.
- To set the auto-run, click on  or save and send to the EVM (for more details see [“Saving and sending configurations”](#)).

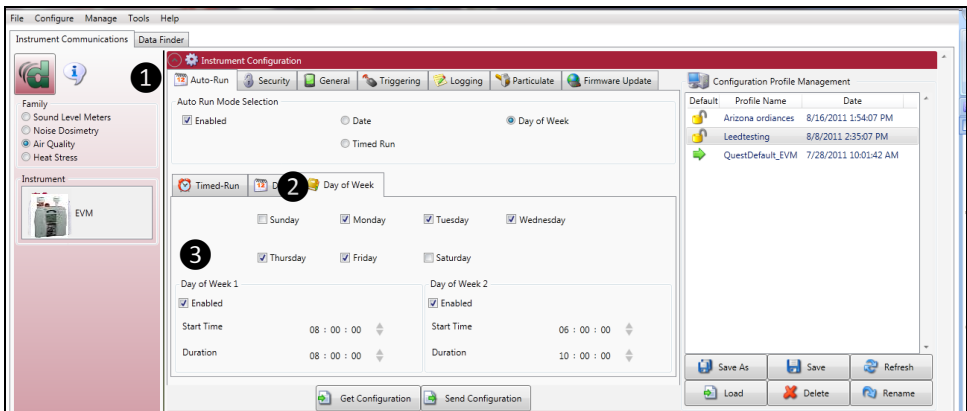

Figure 6-12: EVM Auto-Run with Day of Week setting

## EVM and Security Settings

The security or lock feature is used to prevent a user from interrupting a run and/or prevents someone from changing a setup or saved setups on the instrument.

☑ **NOTE:** A default code, “9157”, will disable secure run or secure setup if the numeric Passcode is forgotten.

1. Click on the **Security** tab (see ❶) from the EVM's Instrument Communications panel.
2. To set the **Secure Setup Mode** or **Secure Run Mode**, follow below:
  - Click in the **Enabled**  box to turn on secure run setup mode and/or secure run mode.
3. Type in a passcode (4 numeric characters).
4. To set the auto-run, click on  or save and send to the EVM (for more details see [“Saving and sending configurations”](#)).

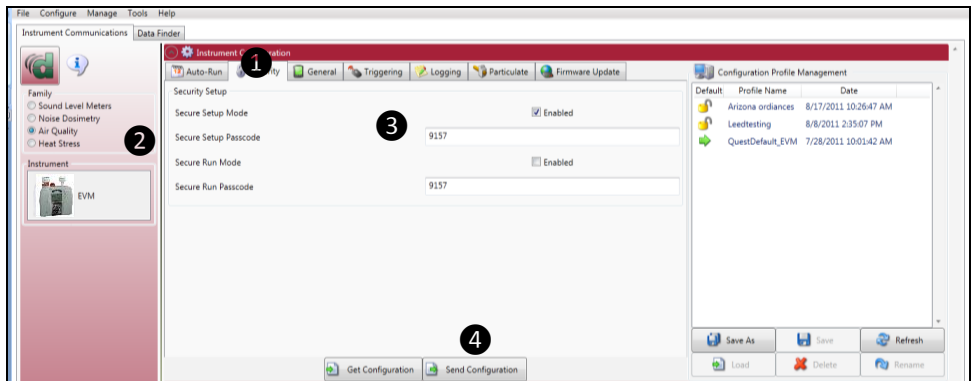

Figure 6-13: EVM Auto-Run with Day of Week setting

## EVM and Triggering Settings

There are two types of triggering outputs which may be programmed to with one of the seven sensors.

☑ **NOTE:** Refer to the EVM triggering table identifies the components of this setup screen.

**Digital output:** You can connect an external device to the monitor. This can be used to signal a specific level to turn on a notification device, an LED, or a fan motor at a specific threshold (or set point). Once enabled, the following three are selectable parameters: a sensor, logic setting, and threshold setting.

**Analog output:** Enables the analog output on the device when checked. The analog output will vary between 0–5 volts based upon the minimum and maximum levels for the particular sensor.

1. Click on the Triggering tab (see ❶) from the EVM's Instrument Communications panel.

- To set the Triggering for **Digital Output** or **Analog Output**, follow the steps below:
  - Click in the Enabled  box to turn on Trigger digital/analog output.
  - For the Logic level, click the  arrow to select a level (for digital output only).
  - For the parameter, select one of the sensors (**Note:** For air velocity, verify the sensor is attached to the EVM and selected in the **General** panel of DMS.)
  - For the threshold, type in a value for the selected parameter or use the  to select.
- To set the triggering setup, click on  or save and send to the EVM (for more details see [“Saving and sending configurations”](#)).

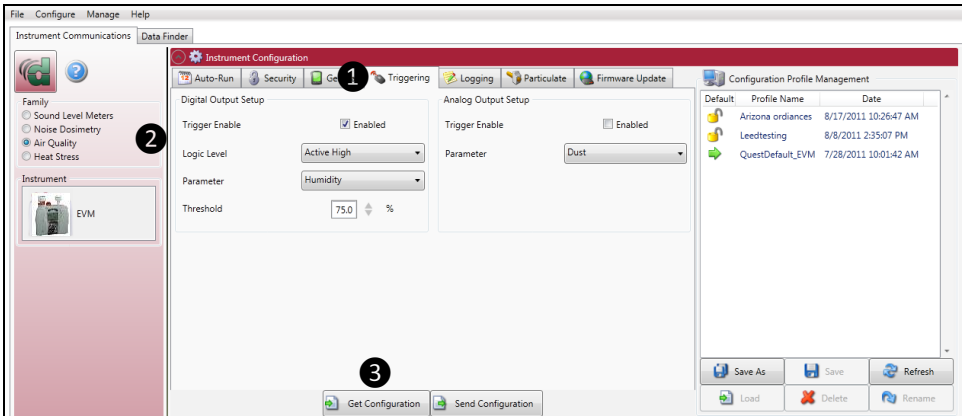

Figure 6-14: EVM Triggering setup

Triggering parameters	Explanation
Digital Output	Enables the digital output on the device when checked per the mode, parameter, and threshold settings. <b>NOTE:</b> Only one of these parameters (Digital Output, Analog Output, or Air Velocity) can be enabled at one time.
Analog Output	Enables the analog output on the device when checked. The analog output will vary between 0-5 volts based upon the minimum and maximum levels for the particular sensor.
Logic level (Also called “Mode” on the EVM)	The type of signal that will be triggered when the parameter and threshold are satisfied. It may either be active high, active low, active high pulse, or active low pulse. (Reference Table 3-3 for detailed information.)
Parameters	The sensor that is to trigger the digital/analog output.
Threshold	The threshold at which the sensor will be triggered for the given parameter.
Air velocity input	Enables the Air Velocity Input when checked. <b>NOTE:</b> This is mutually exclusive with the digital out meaning that only one or the other can be enabled at any given time.
Units	Sets the units in which the wind speed will be measured, either meters per second or feet per minute.

## EVM and Particulate Settings

The particulate settings may be programmed with up to 8 correction factor profiles. It also provides the capability to view the mass and volume of the gravimetric accumulator and gravimetric volume if get configuration is selected. To update, follow below.

1. Click on the **Particulate** tab (see ①) from the EVM's Instrument Communications panel.
2. To customize particulate profile names, double-click on the Name of the particulates (see ②).
  - The edit profile screen will appear (see ③). Type in a name and type in the appropriate correction factor or use the  key to set the numeric value. Repeat this step as necessary to setup eight correction factor profiles.
3. The active profile field (see ④) may be set to a customized profile name with a designated correction factor (see step two for details). To set an active profile, click on the  arrow and select one of the profile names. (Not applicable if step 2 was skipped.)
4. To set the **Units**, select the  arrow and select a unit of measurement.
5. To set the particulates setup, click on  or save and send to the EVM (for more details see "[Saving and sending configurations](#)").

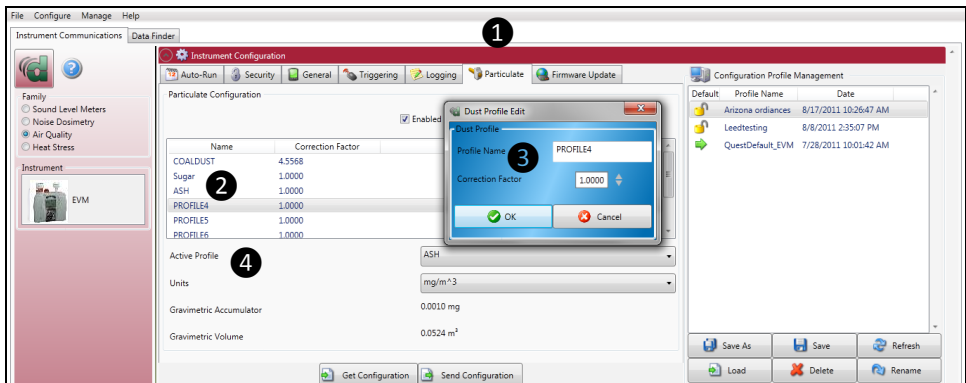

Figure 6-15: EVM Auto-Run with Day of Week

### EVM and Particulates Setup

Particulates setup screen	Explanation
Particulates checkbox	Enables the particulates/dust sensor when checked.
Profile names	Names associated with a given correction factor managed within the EVM device. To edit a given profile name or user correction factor associated with a profile name, double-click the profile name (i.e. PROFILE1) of the desired profile.
Active profile	The profile that is currently being used for dust measurements by the device.

Particulates setup screen	Explanation
Units	Particulate sampling is measured with either mg/m <sup>3</sup> or µg/m <sup>3</sup> . This is selectable via the drop down menu. Particulates setting is either in mg/m <sup>3</sup> (milligrams per cubic meter) or µg/m <sup>3</sup> (micrograms per cubic meter).
Gravimetric accumulator	The amount of dust, in milligrams, that has been accumulated by the dust sensor since the last time it has been reset.
Gravimetric volume	The volume of air that has passed through the gravimetric filter since the last time it has been reset.
Get setup from instrument button	Retrieves the setup configuration from the device for the General, Input / Output, and Dust Configuration tabs.
Send setup to instrument button	Sends the setup configuration from the General, Input / Output, and Dust Configuration tabs to the device.
Saved setups window	From this window you can save or load a default or custom configuration profile that has been or will be archived for quick access.

## EVM Firmware Update

The firmware update screen is used to update the latest software to EVM Series. With a firmware update, the Web Server option enables you to update through an internet connection. If you do not have internet capability, the File option is used in place of the first option.

**NOTE:** Contact TSI, for details on obtaining updates [www.tsi.com](http://www.tsi.com) or email: [technical.services@tsi.com](mailto:technical.services@tsi.com). Follow below to update your instrument.

1. Ensure the EVM Series is communicating. (See “[EVM Communication setup](#)” above for details.)
2. Click on the **Firmware Update** tab and either select **Web Server** or **File**.
3. Click on the  button to send to the instrument.

*(This page intentionally left blank)*

# Maintenance and Cleaning

## Overview

The maintenance and cleaning chapter discusses how to care for the following items:

- [Care and cleaning with the PID sensor](#)
- [PID cleaning kit](#) (optional accessory, part number 074-080, see “[Customer Service](#)” or email [technical.services@tsi.com](mailto:technical.services@tsi.com) for details.)
- [Optical Engine](#): maintenance and cleaning
- [Impactor care](#)
- [Gravimetric cassette and filter paper](#)

## PID Sensor

The following section explains basic installation, maintenance of the PID sensor, and cleaning the lamp.

- ☑ **NOTE:** The PID cleaning kit is sold as an accessory. For technical support, see “[Customer Service](#)” or call TSI at 1-800-680-1220 (USA) or (651) 490-2860.



The Photoionization detection (PID sensor) is used to measure airborne pollutants. As it is measuring and detecting for Volatile Organic Compounds (VOCs), the gases freely diffuse in and out of the sensor chamber which is formed by the filter, housing walls, and a UV lamp opening (window). It is important to keep the UV lamp clean and the electrode pellet (lid placed over the lamp housing) clean.

- ☑ **NOTE: Regarding PID and performance:** with the PID sensor and humidity sensitivity, this uses the **fence electrode technology** to minimize humidity.

## Removing and Installing PID Sensor

If you ordered a PID sensor with your instrument, it will be shipped with an installed PID sensor that was factory calibrated. The following procedures explain how to remove and install the PID sensor.

1. Verify the EVM is powered off and the external power supply is unplugged.
2. Remove the sensor bar by unscrewing the two screws. Next, gently remove the sensor bar, by tilting the front and lifting up. (The rubber gasket may stick a little as you lift the sensor bar off.) Place the sensor bar to the side.
3. A black bar (called the manifold) will be placed over the sensors. Remove this by pulling it out of the housing and set aside.
4. Placing your fingers on the middle sensor (PID sensor), gently tilt the front of sensor up as you pull the sensor out with your thumb and index finger. Place to the side.

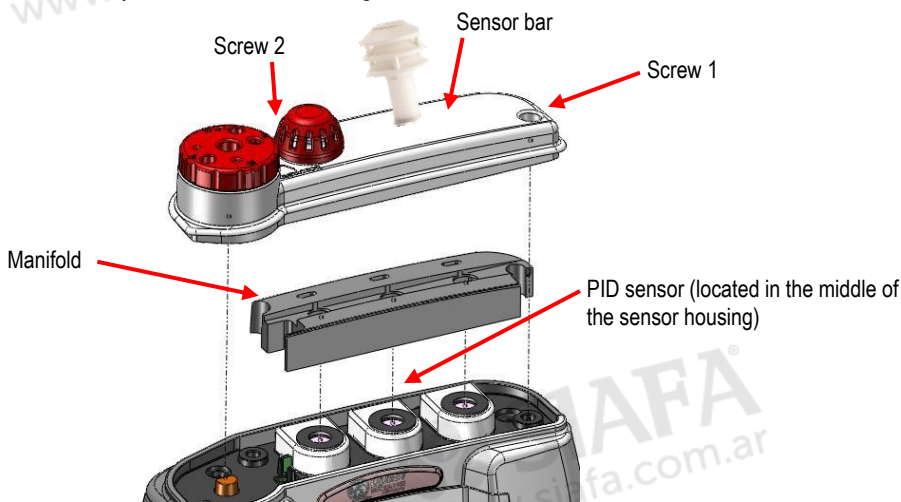

Figure 7-1: Removing and inserting PID sensor

5. To insert the PID sensor, line the pins up to the circuit board and lower it vertically down and gently push it into the sensor cavity. It will fit snug.
6. To reassemble, place the manifold over the sensor housing and then place the sensor bar on top of the manifold and sensor housing. Tighten down the two screws. (See the [Calibration](#) section to perform a calibration with the newly installed sensor).



## Maintenance and Cleaning Overview of PID

Periodic maintenance is encouraged to ensure accurate VOC measurements. If you are in an environment with high concentrations of VOCs with aerosols and high particulates, you will want to check the calibration frequently and clean the components. When the PID loses sensitivity, you will want to change the electrode pellet.

- ☑ **NOTE:** Due to the increased sensitivity of the PID ppb sensor, it is recommended to replace this pellet more often. (See [Appendix A](#) Accessories and adapters for details.)

The following are **three recommended maintenance/cleaning benchmarks**, recommended by Ion Science.

1. After performing a zero calibration, the baseline climbs. (You should replace the electrode pellet).
2. Under highly humid conditions, replacement of the electrode is needed.
3. If the baseline is unstable or shifts when you move the PID, then cleaning is needed.

## Cleaning PID Sensor

Cleaning of the PID sensor requires removing the plastic, intelligent sensor casing, removing the electrode pellet, and removing the lamp. Once removed, the lamp is cleaned off with the cleaning kit (available as an optional accessory). The flowing procedures explain how to clean the PID sensor components.

### ➤ Removing and Cleaning the sensor

1. Remove the PID sensor (follow steps outlined in, "[Removing and Installing PID Sensor.](#)")
2. Using a flat-head screwdriver, gently pry open the plastic, intelligent sensor casing where the small rectangle crevice is on the backside of the housing. Using some force, lift the top off (the bottom section is glued in.)



Figure 7-2: Removing intelligent-sensor casing with PID

## Cleaning PID Sensor

3. Using the pellet removal **tool** (displayed below), insert into the side crevices and place your thumb over the black pellet.
  - ☑ **NOTE:** Once you squeeze the pellet removal tool, the lid will pop off with the lamp. In order to prevent it from popping out, it is important to place your thumb over the black pellet first.



**Figure 7-3: Removing the lamp with removal tool**

4. Set the electrode pellet and lamp to the side.
  - ☑ **NOTE:** Use a paper towel, or a cloth without fibers, when handling these pieces to prevent oils from your hands transferring to the lamp or pellet.

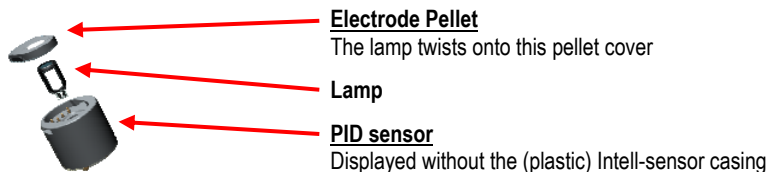

**Figure 7-4: Remove/insert PID sensor with lamp & pellet**

5. Using the PID cleaning kit (*optional accessory*), open the alumina oxide polishing compound and insert a cotton swab.
  - In a circular motion, polish the lamp until an audible squeaking sound is heard (about 15 seconds). **DO NOT** touch the lamp window with your fingers. Remove any residuals of the compound with a cotton swab.



### Caution

The cleaning compound, alumina oxide, should not be inhaled and can be an irritant to your eyes. Be cautious when handling the powder compound



**Figure 7-5: PID sensor cleaning kit (optional accessory)**

6. To refit the lamp and electrode pellet properly, it is recommended to twist the lamp into the O-ring of the electrode pellet (twist clock-wise one full turn) ensuring you use a cloth (with no fibers).
7. Then, lower into the PID sensor as displayed below.

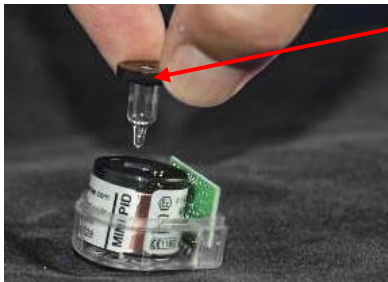

Electrode Pellet and lamp attached

**Figure 7-6: Fitting/Inserting the lamp and pellet**

8. Place the plastic Intel-sensor casing over the sensor. Press firmly to snap it into place.
9. Insert it back into the sensor housing as explained in “Removing and inserting PID sensor”.
10. After cleaning, you need to perform a zero and span calibration (see PID calibration.)

## Optical Engine: Maintenance and Cleaning

The optical engine should be cleaned when the following conditions occur:

- It will not zero
- Exposed to oily or wet mists.
- Readings are falling lower and lower indicating dirty mirror

To clean the optical engine, this requires the use of a 1/16th Allen wrench and a cotton swab.

➤ **Maintenance and cleaning of the optical engine**

1. Remove the two screws on the optical engine using a Phillips screwdriver.
2. You have two options when removing the screws:
  - Your first option is to loosen the two screws and turn the D-Ring so the flat angle is facing the circular metal plate.
  - Your second option is to remove the two screws and D-ring and set these aside.

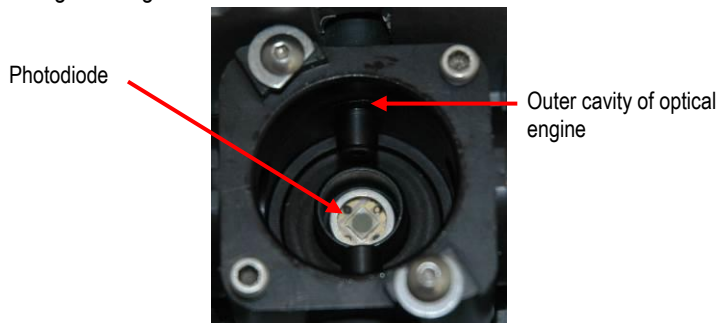

Figure 7-7: Optical engine and cleaning

3. Next, lift the spherical mirror up and off by using a flat-headed screwdriver. Using a clean cotton swab, **gently** wipe the spherical mirror in a circular motion. Set aside.
4. Using a clean cotton swab, **gently** wipe around the outer cavity of the optical engine.



5. For the photodiode (positioned on the bottom of the optical engine), **gently** wipe around the bottom of the optical engine using a clean cotton swab/cotton ball.



**Figure 7-8: Cleaning the optical engine**

6. Place the spherical mirror back over the optical engine. Gently push it into the cavity of the optical engine.
  - ☑ **NOTE:** If you loosened the D-ring and screws, ensure the flat side of the D-ring is facing the metal ring as you place it back into place. If you removed the screws and the D-ring, this will not apply.
7. Tighten down the two screws and D-rings with the Phillips screwdriver.

## Impactor Care

The impactor will require periodic greasing and cleaning which is dependent on the density of air particulates floating in the intended measurement environment.

☑ **NOTE:** The impactor must be greased before your first measurement.

➤ **Greasing and cleaning impactors explained below:**

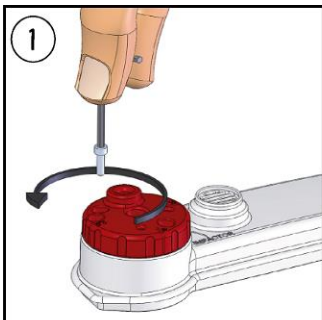

1 REMOVE TWO OUTER SCREWS. DO NOT REMOVE CENTER SCREW

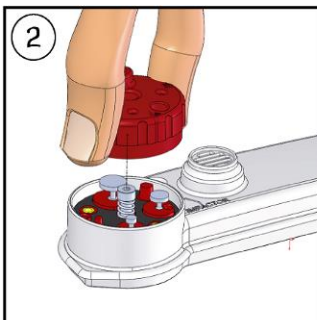

2 REMOVE TURRET TOP

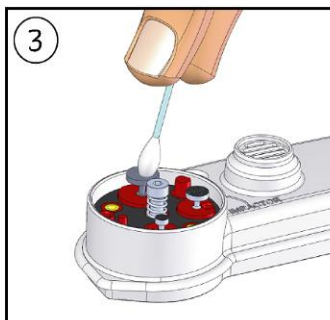

3 USE A SWAB OR PAPER TOWEL TO CLEAN DUST FROM THREE IMPACTORS

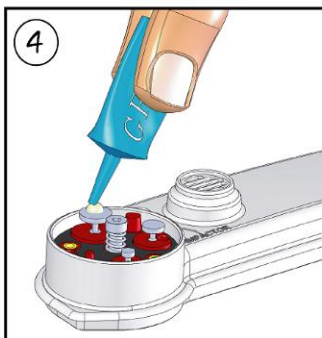

4 APPLY A SMALL AMOUNT OF GREASE TO TOPS OF THREE IMPACTORS

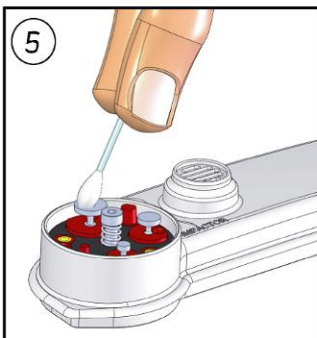

5 USE SWAB OR FINGER TO SPREAD GREASE INTO VERY THIN LAYER

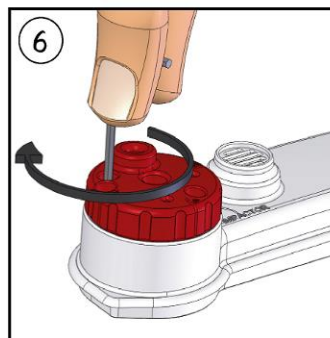

6 REPLACE TURRET TOP AND SECURE WITH SCREWS, IMPACTORS ARE NOW READY FOR DUST SAMPLING

## Impactors and When To Clean

When the dust accumulates on top of impactor plate in a pyramid form (as displayed in the figure below), this signifies the impactor plate requires cleaning.

For example, in a dense, dusty manufacturing plant, this may require greasing and cleaning after each measurement or every 10 hours of measuring.

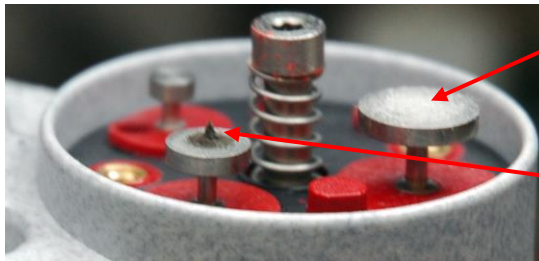

Apply a **very thin-film of silicone grease** before calibrating and measuring (on the appropriate impactor setting.)

When dust accumulates in a pyramid form on top of the impactor, this indicates cleaning is required.

Figure 7-9: When to clean impactors

## Gravimetric Cassette and Filter Paper

A filter paper in the gravimetric cassette (also referred to as “gravimetric pump protection filter”) is user-replaceable and is included in your kit. It is suggested to replace the filter paper when the flow rate is not maintained. The instrument will display a warning message when it needs replacing.

### ➤ Replacing the filter paper in the gravimetric cassette

1. Remove the cassette by opening the back door and gently remove the cassette from the housing.
2. Open the gravimetric cassette by twisting the two pieces apart.
3. Remove the filter paper and replace it with a new paper.
4. Put the cassette back together and insert it back into the housing.

☑ **NOTE:** When installing the cassette, make sure the side labeled inlet is attached to optical engine. Also the filter paper should be on the bottom of the cassette.

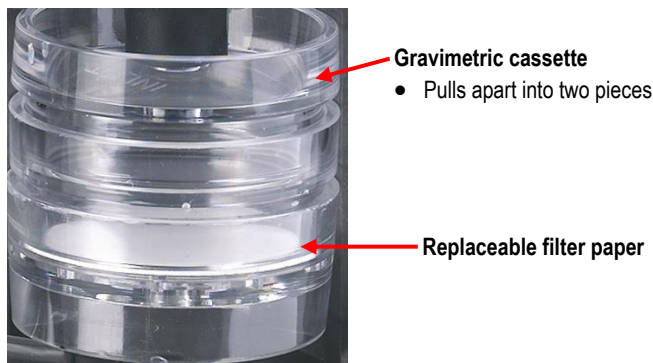

Figure 7-10: Gravimetric cassette and filter paper maintenance

*(This page intentionally left blank)*



# Specifications

## Particulate Sensor

Method	Display Range	Display Resolution	Accuracy/Repeatability
Photometer	0.000- 200.0 mg /m <sup>3</sup> (Non-condensing)	0.001	±15% (Calibrated to Arizona road dust; ISO 12103-1, A2 Fine Test Dust)
	0 to 20,000 µg/m <sup>3</sup>	1	
Particulates	0.1 – 10 µm	N/A	*See note below

Particulate Sensor - General	
Size	0.1 µm to 10 µm* (*Note: The photometer can detect particles up to 100 µm; however, accuracy is reduced for sizes greater than 10 µm It may not be as accurate.)
Impactor- mechanical	Top-mounted, rotary impactor particulate filter
Impactor settings	PM2.5, PM4, PM10 or PM at 1.67 Liter/minute flow rate
Measures	Real-time aerosol/dust concentration using a 90° optical light scattering photometer to report total mass concentration (mg/m <sup>3</sup> or µg/m <sup>3</sup> ) of particulate matter
Gravimetric sampling	<ul style="list-style-type: none"> <li>Flow: ± 5%, after calibration</li> <li>Back-pressure @ gravimetric cassette                             <ul style="list-style-type: none"> <li>≥ 5 kPa</li> <li>≥ 20 inches of water @ 1.67 L/min</li> </ul> </li> </ul>
Dust correction factors	Up to 8 User-defined particulate correction factors. To correct for variation from "Arizona Road Dust".
Life expectancy/Warranty	5,000 hours (for the laser photo-meter)/1 year warranty

## Volatile Organic Compounds (VOCs) Gas Detector (PID Sensor)

Method & Detector	Display Range	Display Resolution	Accuracy/Repeatability
Low sensitivity PID	0.00 to 2,000 ppm or mg/m <sup>3</sup> ; (Non-condensing)	0.01 ppm	±5% / 2%; (relative Isobutylene) at cal value
High sensitivity PID • 10.6 electron-Volt Photo-ionization Detector	0 – 50,000 ppb* or µg/m <sup>3</sup> ; (Non-condensing)	1 ppb	±5% / 2%; (relative Isobutylene) at cal value
Life expectancy/Warranty	2,000 hours in clean air environment (replaceable bulb and grid)/ 1 year warranty		

## Carbon Dioxide Sensor

Method & Detector	Display Range	Display Resolution	Accuracy/Repeatability
<b>CO<sub>2</sub> sensor</b> • NDIR (non-dispersive infrared)  *See CO <sub>2</sub> sensor for more details (FAQ section).	0 to 5,000 ppm; auto-ranging (Non-condensing) *Note: Manufactured before Qtr3 2012 range is 0 to 20,000 ppm.	1 ppm	±100 ppm @ 20°C, 1 bar pressure at 2,000 ppm applied gas.
<b>Temperature Influence</b>	additional ±0.2%		
<b>Settling time</b>	90% of change in <90 seconds		
<b>Life expectancy/Warranty</b>	5 years/ 1 year warranty		

## Relative Humidity Sensor

Method & Detector	Display Range	Display Resolution	Accuracy/Repeatability
<b>RH sensor</b> • Capacitive	0.0 to 100%	0.1	± 5% RH signal between 10 – 90%
<b>Temperature Influence</b>	0.1%		
<b>Settling time</b>	90% of change in 15 seconds		
<b>Life expectancy/Warranty</b>	2 years/ 1 year warranty		

## Temperature Sensor

Method & Detector	Display Range	Display Resolution	Accuracy/Repeatability
<b>Temp sensor</b> • Junction Diode	• 0.0 °C to 60.0 °C • 14.0° F to 140.0° F	0.1 0.1	± 1.1 °C (± 2 °F) ± 2°F
<b>Life expectancy/Warranty</b>	2 years/ 1 year warranty		

## Toxic Gas Sensors

Gas Type	Display Range	Display Resolution	Accuracy/ Repeatability	Life expectancy/ warranty
Carbon Monoxide (CO)	0 – 1000 ppm	1 ppm	5%/ 2% of signal	2 years/ 2 years
Chlorine (CL <sub>2</sub> )	0.0 – 20 ppm	0.1 ppm	5%/ 2% of signal	2 years/1 year
Ethylene Oxide (EtO)	0.0 – 20 ppm	0.1 ppm	5%/ 2% of signal	2 years/1 year
Hydrogen Cyanide (HCN)	0 – 50 ppm	0.1 ppm	5%/ 2% of signal	2 years/1 year
Hydrogen Sulfide (H <sub>2</sub> S)	0 – 500 ppm	1 ppm	5%/ 2% of signal	2 years/1 year
Nitrogen Dioxide (NO <sub>2</sub> )	0.0 – 50 ppm	0.1 ppm	5%/ 2% of signal	2 years/1 year
Nitric Oxide (NO)	0.00 – 100 ppm	0.1 ppm	5%/ 2% of signal	2 years/1 year
Oxygen (O <sub>2</sub> )	0.0 – 30 %	0.1 %	5%/ 2% of signal	2 years/ 2 years
Ozone (O <sub>3</sub> )	0 – 1.0 ppm	0.01 ppm	5%/ 2% of signal	18 months/12 months (sensitivity drift 10% over 6 years)
Sulphur Dioxide (SO <sub>2</sub> )	0.0 – 50 ppm	0.1 ppm	5%/ 2% of signal	2 years/1 year

## Air Velocity Accessory (Optional – Air Probe 10)

Method & Detector	Display Range	Display Resolution	Accuracy/Repeatability
Omni-directional heated thermistor windprobe	0.0 – 20.0 m/s	0.1	± (0.12 m/s + 4.5 %)*
	0 – 3940.0 ft/min	1	± (23.6 ft/min + 4.5 %)*) *of measurement value
Battery life	6 - 8 hours for fully charged NiMH battery		
Charge time	9 hours		
Life expectancy/Warranty	1 year/ 5 years		

## Displayed Data

Measurements	Level, Minimum, Maximum, Average, Short-Term Exposure Level (STEL), Time Weighted Average (TWA)
Real-time measurements	Once per second display update rate
Time history data logging intervals	1, 5, 15, 30 seconds, 1, 5, 10, 15, 30 and 60 minutes
Trend graphing intervals for all parameters	1.5, 3, 15 minutes, 1.5, 3, 8, 12 and 24 hours
Status indicators	Battery, Run, Pause, Stop, Overload and Under Range

## Electrical Characteristics

<b>Battery life</b>	Approximately <b>8+</b> hours of continuous operation at normal operation under reference to environmental conditions when full capacity batteries are installed.
<b>Battery pack</b>	Rechargeable Lithium-Ion
<b>External DC power input</b>	10 to 16 Volt Power Inlet (Nominal 12VDC) 1.5A
<b>Power adapter</b>	Universal AC adapter 100 to 240 VAC; 50-60 Hz
<b>Memory capacity</b>	2 MB – over 24 hours at 15 second logging interval

## Environmental effects

The typical time interval needed to stabilize after changes in environmental conditions is 5 minutes for each 10°C change.

<b>Operating Conditions</b>	<b>Temperature:</b> 0 °C to + 50 °C (32 °F to 122 °F)
	<b>Pressure Range:</b> 65 KPa to 108 kPa
	<b>Relative Humidity Range:</b> 10% to 90%, Non-Condensing
<b>Storage Conditions</b>	<b>Temperature:</b> -20 °C to + 60 °C (-4 °F to + 140 °F)
	<b>Relative Humidity Range:</b> 0 to 95%, Non-Condensing
	<b>Battery:</b> Insure battery is re-charged every 6 months during long-term storage.

## Physical characteristics

<b>Size and weight</b>	19 cm x 19 cm x 7 cm (7.5" x 7.5" x 2.75")
<b>Weight</b>	1.3 kg (2.9 lb)
<b>Housing</b>	Static dissipative ABS-Polycarbonate
<b>Display size</b>	128 x 64 pixel display that measures 6 cm x 4.8 cm (2.4 in. x 1.9 in.)
<b>Backlighting</b>	Manual setting
<b>Keys</b>	Five keys have dedicated control functions, another five are primarily used for selection and navigation, and another four provide variable functions when they are defined in the display (soft keys). Audible (beep) feedback

## Measurements units

<b>Particulates</b>	mg/m <sup>3</sup>
<b>Carbon Dioxide</b>	ppm
<b>Relative Humidity</b>	%
<b>Temperature</b>	°C or °F
<b>Toxic Gas</b>	ppm (Option) (Using one of the toxic sensors indicated in "Toxic Sensors")
<b>VOCs</b>	ppm or ppb (Options) (Using PID – 10.6eV Photo Ionization Detector)
<b>Air Velocity</b>	m/s or m/ft (Options) (Using external air probe accessory)

## Operating Modes

<b>Live-view screen</b>	Pause/Stop modes and Time History Review screen Pause/Stop modes
<b>Logging screen</b>	Run mode and Time History Review screen Run mode
<b>Settings</b>	Stop mode
<b>Calibration</b>	Stop mode
<b>Power/Charging</b>	Off mode
<b>Charging</b>	Charging status screen

## Time Constants

1 second display update rate with 1 to 30 seconds time constants. (Specifications made at 15 seconds time constant.)

## Special Functions

<b>Auto-Run</b>	Programmable via the EVM setup screen or in DMS (TSI Detection Management Software)
<b>Security</b>	Securing or locking run mode and/or setup via the EVM setup screen or in DMS
<b>Software</b>	TSI Detection Management Software DMS is a user friendly compatible software available for advanced analysis with charts, graphs, reporting, and management of tests.
<b>Sensors</b>	Auto-detectable when inserted at powered-off mode and then powered on
<b>Languages include</b>	English, Spanish, German, French, Italian, and Portuguese
<b>Certified</b>	CE Mark and RoHS compliance
<b>Patents</b>	USPC Class: 73 2805 Class name: Solid content of gas separator detail impactor Publication date: 03/05/2009 Patent application number: 20090056417

## Estimated Logged Run Times

### Standard EVM-7 (Memory and logged time)

(Logging the following Sensors: Dust, Temp, Humidity, CO<sub>2</sub>, Toxic, PID, Dew Pt)

Run Time (Hours)					
Logging Rate	Number of Measurements Logged				
	1	2	3	4	5
1 seconds	31.0	15.5	10.3	7.7	6.2
5 seconds	154.9	77.5	51.6	38.7	31.0
15 seconds	464.8	232.4	154.9	116.2	93.0
1 seconds	31.0	15.5	10.3	7.7	6.2
5 seconds	154.9	77.5	51.6	38.7	31.0
15 seconds	464.8	232.4	154.9	116.2	93.0
30 seconds	929.6	464.8	309.9	232.4	185.9
1 minute	1859.2	929.6	619.7	464.8	371.8
5 minutes	9296.1	4648.0	3098.7	2324.0	1859.2
10 minutes	18592.1	9296.1	6197.4	4648.0	3718.4
15 minutes	27888.2	13944.1	9296.1	6972.1	5577.6
30 minutes	55776.4	27888.2	18592.1	13944.1	11155.3
1 hour	111552.8	55776.4	37184.3	27888.2	22310.6

Run Time (Days)					
Logging Rate	Number of Measurements Logged				
	1	2	3	4	5
1 seconds	1.3	0.6	0.4	0.3	0.3
5 seconds	6.5	3.2	2.2	1.6	1.3
15 seconds	19.4	9.7	6.5	4.8	3.9
30 seconds	38.7	19.4	12.9	9.7	7.7
1 minute	77.5	38.7	25.8	19.4	15.5
5 minutes	387.3	193.7	129.1	96.8	77.5
10 minutes	774.7	387.3	258.2	193.7	154.9
15 minutes	1162.0	581.0	387.3	290.5	232.4
30 minutes	2324.0	1162.0	774.7	581.0	464.8
1 hour	4648.0	2324.0	1549.3	1162.0	929.6

Run Time (Years)					
Logging Rate	Number of Measurements Logged				
	1	2	3	4	5
1 seconds	0.0	0.0	0.0	0.0	0.0
5 seconds	0.0	0.0	0.0	0.0	0.0
15 seconds	0.1	0.0	0.0	0.0	0.0
30 seconds	0.1	0.1	0.0	0.0	0.0
1 minute	0.2	0.1	0.1	0.1	0.0
5 minutes	1.1	0.5	0.4	0.3	0.2
10 minutes	2.1	1.1	0.7	0.5	0.4
15 minutes	3.2	1.6	1.1	0.8	0.6
30 minutes	6.4	3.2	2.1	1.6	1.3
1 hour	12.7	6.4	4.2	3.2	2.5

## Standard EVM-4 (Memory and logged time)

(Logging the following Sensors: Temp, Humidity, CO<sub>2</sub>, Toxic, Dew Pt)

Run Time (Hours)					
Logging Rate	Number of Measurements Logged				
	1	2	3	4	5
1 seconds	49.6	24.8	16.5	12.4	9.9
5 seconds	247.9	123.9	82.6	62.0	49.6
15 seconds	743.7	371.8	247.9	185.9	148.7
30 seconds	1487.4	743.7	495.8	371.8	297.5
1 minute	2974.7	1487.4	991.6	743.7	594.9
5 minutes	14873.7	7436.9	4957.9	3718.4	2974.7
10 minutes	29747.4	14873.7	9915.8	7436.9	5949.5
15 minutes	44621.1	22310.6	14873.7	11155.3	8924.2
30 minutes	89242.2	44621.1	29747.4	22310.6	17848.4
1 hour	178484.5	89242.2	59494.8	44621.1	35696.9

Run Time (Days)					
Logging Rate	Number of Measurements Logged				
	1	2	3	4	5
1 seconds	2.1	1.0	0.7	0.5	0.4
5 seconds	10.3	5.2	3.4	2.6	2.1
15 seconds	31.0	15.5	10.3	7.7	6.2
30 seconds	62.0	31.0	20.7	15.5	12.4
1 minute	123.9	62.0	41.3	31.0	24.8
5 minutes	619.7	309.9	206.6	154.9	123.9
10 minutes	1239.5	619.7	413.2	309.9	247.9
15 minutes	1859.2	929.6	619.7	464.8	371.8
30 minutes	3718.4	1859.2	1239.5	929.6	743.7
1 hour	7436.9	3718.4	2479.0	1859.2	1487.4

Run Time (Years)					
Logging Rate	Number of Measurements Logged				
	1	2	3	4	5
1 seconds	0.0	0.0	0.0	0.0	0.0
5 seconds	0.0	0.0	0.0	0.0	0.0
15 seconds	0.1	0.0	0.0	0.0	0.0
30 seconds	0.2	0.1	0.1	0.0	0.0
1 minute	0.3	0.2	0.1	0.1	0.1
5 minutes	1.7	0.8	0.6	0.4	0.3
10 minutes	3.4	1.7	1.1	0.8	0.7
15 minutes	5.1	2.5	1.7	1.3	1.0
30 minutes	10.2	5.1	3.4	2.5	2.0
1 hour	20.4	10.2	6.8	5.1	4.1



## Standard EVM-3 (Memory and logged time)

(Logging the following Sensors: Dust, Temp, Humidity, Dew Pt)

Run Time (Hours)					
Logging Rate	Number of Measurements Logged				
	1	2	3	4	5
1 seconds	49.6	24.8	16.5	12.4	9.9
5 seconds	247.9	123.9	82.6	62.0	49.6
15 seconds	743.7	371.8	247.9	185.9	148.7
30 seconds	1487.4	743.7	495.8	371.8	297.5
1 minute	2974.7	1487.4	991.6	743.7	594.9
5 minutes	14873.7	7436.9	4957.9	3718.4	2974.7
10 minutes	29747.4	14873.7	9915.8	7436.9	5949.5
15 minutes	44621.1	22310.6	14873.7	11155.3	8924.2
30 minutes	89242.2	44621.1	29747.4	22310.6	17848.4
1 hour	178484.5	89242.2	59494.8	44621.1	35696.9

Run Time (Days)					
Logging Rate	Number of Measurements Logged				
	1	2	3	4	5
1 seconds	2.1	1.0	0.7	0.5	0.4
5 seconds	10.3	5.2	3.4	2.6	2.1
15 seconds	31.0	15.5	10.3	7.7	6.2
30 seconds	62.0	31.0	20.7	15.5	12.4
1 minute	123.9	62.0	41.3	31.0	24.8
5 minutes	619.7	309.9	206.6	154.9	123.9
10 minutes	1239.5	619.7	413.2	309.9	247.9
15 minutes	1859.2	929.6	619.7	464.8	371.8
30 minutes	3718.4	1859.2	1239.5	929.6	743.7
1 hour	7436.9	3718.4	2479.0	1859.2	1487.4

Run Time (Years)					
Logging Rate	Number of Measurements Logged				
	1	2	3	4	5
1 seconds	0.0	0.0	0.0	0.0	0.0
5 seconds	0.0	0.0	0.0	0.0	0.0
15 seconds	0.1	0.0	0.0	0.0	0.0
30 seconds	0.2	0.1	0.1	0.0	0.0
1 minute	0.3	0.2	0.1	0.1	0.1
5 minutes	1.7	0.8	0.6	0.4	0.3
10 minutes	3.4	1.7	1.1	0.8	0.7
15 minutes	5.1	2.5	1.7	1.3	1.0
30 minutes	10.2	5.1	3.4	2.5	2.0
1 hour	20.4	10.2	6.8	5.1	4.1

## Accessories: Replacement and Optional Parts

*\*\*All accessories subject to change*

Base Unit Parts & Numbers	Description
074-718	EVM Carry Case, with foam and labels
074-300	EVM Owner's manual
053-263	12 VDC Universal input power supply
053-575	USB cable

Particulate Parts & Numbers	Description
100-456	Silicone dielectric grease for impactors
074-080	PID PPM cleaning kit
074-076-5	5-pack of 37-mm gravimetric cassettes (for pump protection) includes one standard filter
074-090	10-pack of pump protection filters (for 37-mm gravimetric cassette)
074-720	Dust zero calibration filter assembly

<b>Toxic Parts &amp; Numbers</b>	<b>Description</b>
054-875	Carbon monoxide smart sensor
054-881	Chlorine smart sensor
054-722	Ethylene oxide smart sensor
054-886	Hydrogen cyanide smart sensor
054-874	Hydrogen sulfide smart sensor
074-102	Ozone sensor
054-873	Oxygen smart sensor
054-877	Nitric oxide smart sensor
054-880	Nitrogen dioxide smart sensor
054-878	Sulphur dioxide smart sensor
074-726	Toxic calibration adapter

<b>PID Parts &amp; Numbers</b>	<b>Description</b>
074-713	PID PPM smart sensor (includes pellet removal tool)
074-080	PID PPM cleaning kit
074-081	PID PPM replacement lamp
074-082	PID PPM replacement electrode (grid) pellet
074-097	PID PPB smart sensor
074-098	PID PPB replacement lamp
100-460	10 PPM isobutylene cal gas
100-459	Ultra zero grade air cal gas
074-104	PID PPB replacement pellet (grid)

<b>CO<sub>2</sub> Parts &amp; Numbers</b>	<b>Description</b>
074-733	CO <sub>2</sub> Smart sensor. 5-pin sensor. For models manufactured after Qtr 3 2012.
074-712	CO <sub>2</sub> Smart sensor. 7-pin sensor. For models manufactured before Qtr 3 2012.
054-972	1.0 L/min regulator with 2' (0.050" ID) inert tubing

Options Parts & Numbers	Description
054-899	Dummy sensor (used to seal the socket when no gas sensor is present)
053-870	12 VDC car charger adapter
Air Probe-10-120	Air-Probe 10 kit includes 120V charger, adapter cable and mounting bracket.
Air Probe-10-220	Air-Probe 10 kit includes 220V charger, adapter cable and mounting bracket.
074-083	Air-Probe adapter cable (included with each air probe option)

## Customer Service

This section gives directions for contacting TSI Incorporated for technical information and directions for returning the EVM Series Environmental Monitor for service.

### Technical Support Contacts

If you have any difficulty setting or operating the instrument, or if you have technical or application questions about this system, contact TSI's Technical Support.

North America and Asia Pacific	Europe, Middle East, and Africa
<b>Telephone:</b> 1-800-680-1220 (USA); +1 651-490-2860 (Outside USA)	<b>Telephone:</b> +49 241-52303-0
<b>Fax:</b> +1 651-490-3824	<b>Fax:</b> +49 241 52303-49
<b>E-mail:</b> <a href="mailto:technical.services@tsi.com">technical.services@tsi.com</a>	<b>E-mail:</b> <a href="mailto:tsigmbh@tsi.com">tsigmbh@tsi.com</a>

### Service Contact Information

If your instrument does not operate properly, or if you are returning the instrument for service, visit our website at <http://rma.tsi.com> for a Return Material Authorization, or contact Customer Service.

North America and Asia Pacific	Europe, Middle East, and Africa
<b>TSI Incorporated</b> 1060 Corporate Center Drive Oconomowoc, WI 53006-4828	<b>TSI Instruments Ltd.</b> Stirling Road Cressex Business Park High Wycombe, Bucks HP12 3ST United Kingdom
<b>Telephone:</b> 1-800-680-1220 (USA); +1 651-490-2860 (Outside USA)	<b>Telephone:</b> +44 (0) 149 4 459200
<b>E-mail:</b> <a href="mailto:technical.services@tsi.com">technical.services@tsi.com</a>	<b>E-mail:</b> <a href="mailto:tsiuk@tsi.com">tsiuk@tsi.com</a>

## Returning for Service

Visit our website at <http://rma.tsi.com> and complete the on-line "Return Merchandise Authorization" form or call TSI at 1-800-680-1220 (USA) or (651) 490-2860, or 001 651 490 2860 (International) for specific return instructions.

Customer Service will need the following information:

- The instrument model number
- The instrument serial number
- A purchase order number (unless under warranty)
- A billing address
- A shipping address

Use the original packing material to return the instrument to TSI. If you no longer have the original packing material, seal off any ports to prevent debris from entering the instrument and ensure that the display and the connectors on the instrument front and back panels are protected. This instrument is very fragile and must be packed in a manner appropriate for a precision instrument.

## Calibration

The EVM Series and TSI field calibrator devices should be examined regularly by the factory. An annual calibration is recommended. (see Service Department above.)

# Warranty

(For country-specific terms and conditions outside of the USA, please visit [www.tsi.com](http://www.tsi.com).)

Seller warrants the goods, excluding software, sold hereunder, under normal use and service as described in the operator's manual, to be free from defects in workmanship and material for **12 months**, or if less, the length of time specified in the operator's manual, from the date of shipment to the customer. This warranty period is inclusive of any statutory warranty. This limited warranty is subject to the following exclusions and exceptions:

- a. Hot-wire or hot-film sensors used with research anemometers, and certain other components when indicated in specifications, are warranted for 90 days from the date of shipment;
- b. Pumps are warranted for hours of operation as set forth in product or operator's manuals;
- c. Parts repaired or replaced as a result of repair services are warranted to be free from defects in workmanship and material, under normal use, for 90 days from the date of shipment;
- d. Seller does not provide any warranty on finished goods manufactured by others or on any fuses, batteries or other consumable materials. Only the original manufacturer's warranty applies;
- e. This warranty does not cover calibration requirements, and seller warrants only that the instrument or product is properly calibrated at the time of its manufacture. Instruments returned for calibration are not covered by this warranty;
- f. This warranty is **VOID** if the instrument is opened by anyone other than a factory authorized service center with the one exception where requirements set forth in the manual allow an operator to replace consumables or perform recommended cleaning;
- g. This warranty is **VOID** if the product has been misused, neglected, subjected to accidental or intentional damage, or is not properly installed, maintained, or cleaned according to the requirements of the manual. Unless specifically authorized in a separate writing by Seller, Seller makes no warranty with respect to, and shall have no liability in connection with, goods which are incorporated into other products or equipment, or which are modified by any person other than Seller.

The foregoing is **IN LIEU OF** all other warranties and is subject to the LIMITATIONS stated herein. **NO OTHER EXPRESS OR IMPLIED WARRANTY OF FITNESS FOR PARTICULAR PURPOSE OR MERCHANTABILITY IS MADE. WITH RESPECT TO SELLER'S BREACH OF THE IMPLIED WARRANTY AGAINST INFRINGEMENT, SAID WARRANTY IS LIMITED TO CLAIMS OF DIRECT INFRINGEMENT AND EXCLUDES CLAIMS OF CONTRIBUTORY OR INDUCED INFRINGEMENTS. BUYER'S EXCLUSIVE REMEDY SHALL BE THE RETURN OF THE PURCHASE PRICE DISCOUNTED FOR REASONABLE WEAR AND TEAR OR AT SELLER'S OPTION REPLACEMENT OF THE GOODS WITH NON-INFRINGEMENTS.**

TO THE EXTENT PERMITTED BY LAW, THE EXCLUSIVE REMEDY OF THE USER OR BUYER, AND THE LIMIT OF SELLER'S LIABILITY FOR ANY AND ALL LOSSES, INJURIES, OR DAMAGES CONCERNING THE GOODS (INCLUDING CLAIMS BASED ON CONTRACT, NEGLIGENCE, TORT, STRICT LIABILITY OR OTHERWISE) SHALL BE THE RETURN OF GOODS TO SELLER AND THE REFUND OF THE PURCHASE PRICE, OR, AT THE OPTION OF SELLER, THE REPAIR OR REPLACEMENT OF THE GOODS. IN THE CASE OF SOFTWARE, SELLER WILL REPAIR OR REPLACE DEFECTIVE SOFTWARE OR IF UNABLE TO DO SO, WILL REFUND THE PURCHASE PRICE OF THE SOFTWARE. IN NO EVENT SHALL SELLER BE LIABLE FOR LOST PROFITS, BUSINESS INTERRUPTION, OR ANY SPECIAL, INDIRECT, CONSEQUENTIAL OR INCIDENTAL DAMAGES. SELLER SHALL NOT BE RESPONSIBLE FOR INSTALLATION, DISMANTLING OR REINSTALLATION COSTS OR CHARGES. No Action, regardless of form, may be brought against Seller more than 12 months after a cause of action has accrued. The goods returned under warranty to Seller's factory shall be at Buyer's risk of loss, and will be returned, if at all, at Seller's risk of loss.

Buyer and all users are deemed to have accepted this LIMITATION OF WARRANTY AND LIABILITY, which contains the complete and exclusive limited warranty of Seller. This LIMITATION OF WARRANTY AND LIABILITY may not be amended, modified or its terms waived, except by writing signed by an Officer of Seller.

## Service Policy

Knowing that inoperative or defective instruments are as detrimental to TSI as they are to our customers, our service policy is designed to give prompt attention to any problems. If any malfunction is discovered, please contact your nearest sales office or representative, or call TSI's Customer Service department at 1-800-874-2811 (USA) or +001 (651) 490-2811 (International).

*(This page intentionally left blank)*



# Glossary of Terms

Term	Definition
<b>ACGIH</b>	The American Conference of Governmental Industrial Hygienists organization in the United States.
<b>Air monitoring</b>	Sampling for pollutants in the air using a variety of means such as sorbent tubes, bags, filters and sampling conventions.
<b>Air pollutant</b>	Any substance in air that could, in high enough concentration, harm man, other animals, vegetation, or material. Pollutants may include almost any natural or artificial composition of airborne matter capable of being airborne. They may be in the form of solid particles, liquid droplets, gases, or in combination.
<b>Air pollution</b>	Air pollution are chemicals present in the atmosphere which are normally not a part of the atmosphere. Basically, air pollution is air that is contaminated, interferes with human health or welfare, or harms the environment. Some examples include dust, smoke, and a variety of toxic gases such as carbon monoxide.
<b>Air quality monitoring</b>	Sampling, measurement/analysis of airborne pollutants.
<b>Air quality standards</b>	The level of pollutants prescribed by regulations that are not to be exceeded during a given time in a defined area.
<b>Airborne particulates</b>	Total suspended particulate matter found in the atmosphere as solid particles or liquid droplets. Chemical composition of particulates varies widely, depending on location and time of year. Airborne particulates include: windblown dust, emissions from industrial processes, smoke from the burning of wood and coal, and motor vehicle or non-road engine exhausts.
<b>ASHRAE</b>	The American Society of Heating, Refrigeration and Air-Conditioning Engineers in the United States.
<b>Bump Test</b>	A functional test of the sensors installed in the gas monitor. Calibration gas is used for a bump test.
<b>Calculating particulate matter</b>	The worker exposure assessment, on the EVM, is based on a gravimetric analysis with filter samples drawn over a period time. If acute effects exist from personal inhalable dust, the sampling analysis allows for short term analysis (STEL).
<b>Ceiling</b>	This is the maximum allowable concentration of a chemical that an employee may be exposed to. It must never be exceeded, even for an instant.
<b>Confined Space (see also "Permit Required Confined Space")</b>	A "Confined Space" has three components: <ul style="list-style-type: none"> <li>a. It is large enough to enter &amp; perform work</li> <li>b. It has limited means for entry &amp; exit</li> <li>c. It is not designed for continuous occupancy</li> </ul>

Term	Definition
<b>Correction Override Factor</b>	This is the correction override factor that is applied during your run or after a run for particulate measurements or PID (VOCs) measurements. In DMS, an override factor can be applied after a run via the Correction Override icon. The applied dust override is displayed in the General Data Panel (if selected under the sensor data list).
<b>Dew Point</b>	The dew point measurement is the absolute measurement of the amount of water vapor in the air (indicating how much humidity is in the air). It is also defined by Wikipedia as, "the temperature to which a given parcel of air must be cooled, at constant barometric pressure, for water vapor to condense into water. The condensed water is called dew. The dew point is also referred to as the saturation point".
<b>Drift</b>	Is a percentage of signal loss of a gas sensor per month.
<b>Dummy Sensor</b>	This is required to cover a sensor socket when no sensor is present to maintain unit to environment sealing capability.
<b>Dust Override Profile</b>	When setting up the Dust profile in DMS, there is an active profile field. The Dust Override profile field corresponds with the active (or applied) dust profile.
<b>Dust monitoring</b>	Dust is typically known as a type of particulate matter or an aerosol with a miniscule diameter of 0.1 µm upwards.
<b>Engulfment</b>	This is the surrounding of a person by finely divided solids or a liquid. A worker in a storage tank filled with sawdust, for example, could fall into an air pocket, be completely surrounded by sawdust, and suffocate to death.
<b>Filtered CO sensor vs. Unfiltered</b>	There is a high cross-sensitivity between CO and H <sub>2</sub> S. A filtered CO sensor lessens the sensitivity of the sensor to H <sub>2</sub> S.
<b>Fire Triangle</b>	A term for the three components required to start a fire: fuel, oxygen, and ignition.
<b>Gravimetric analysis</b>	Describes an analytical chemistry methodology for determining the quantitative mass of a solid. The EVM collects particulates in an internal gravimetric sample holder that are filtered, collected, and weighed to determine the severity of the worker exposure.

Term	Definition
<b>Hazardous Atmosphere</b>	<p>Means an atmosphere presenting a potential for death, disablement, injury, or acute illness from one or more of the following causes:</p> <p>A flammable gas, vapor or mist in excess of 10% of its' lower explosive limit (LEL).</p> <p>An oxygen deficient atmosphere containing less than 19.5% oxygen by volume or an oxygen enriched atmosphere containing more than 23.5% oxygen by volume.</p> <p>Airborne combustible dust at a concentration that meets or exceeds its LEL (airborne combustible dust which obscures vision at five feet or less).</p> <p>An atmospheric concentration of any substance for which a dose or a permissible exposure limit is published in Subpart G, <i>Occupational Health and Environmental Control</i>, or in subpart Z, <i>Toxic and Hazardous Substances</i>, which could result in an employee exposure in excess of its dose or permissible exposure limit, and that could cause death, incapacitation, impairment of ability to self-rescue, injury or acute illness.</p> <p>Any other atmospheric condition that is immediately dangerous to life or health (IDLH).</p>
<b>IDLH (Immediately Dangerous to Life and Health )</b>	<p>Any condition that poses an immediate or delayed threat to life, or that would cause irreversible adverse health effects or that would interfere with an individual's ability to escape unaided from a confined space.</p>
<b>Lockout-Tagout</b>	<p>Placing locks or tags on the energy-isolating device (e.g. breaker boxes, control switches, valves, etc.) to prevent the unauthorized re-energization of the device or circuit while work is being performed by personnel. Tags shall indicate that the energy-isolated device must not be operated until the tag is removed by the individual(s) that installed the tag.</p>
<b>Material Safety Data Sheet</b>	<p>Published for every chemical or substance that may be hazardous; if an exposure limit has been published for a substance being discussed in an MSDS, that limit, such as TWA or PEL, is required to be included in the MSDS publication. Ref: 29 CFR 1910.1200 (g)(2)(i)(C)(2) and (g)(2)(vi). TWA's and PEL's are not available for most chemicals. There are simply too many chemicals, many of which have not gone through the rigorous scientific study and peer review required. The absence of an exposure limit for a substance should not be used to assume that a substance is not hazardous.</p>

Term	Definition	
<b>Measurement parameters</b>	The following measurements are displayed on the instrument and in the Logged data table/chart in DMS.	
	<b>Average</b>	The measurement value over the time interval (or logging interval)
	<b>Level</b>	The instantaneous measurement at a specific point in time.
	<b>Minimum</b>	The minimum measurement over the time interval (or logging interval).
	<b>Maximum</b>	The maximum measurement over the time interval (or logging interval).
	<b>STEL (Short term Exposure Limit)</b>	The maximum concentration above the time-weighted average that employees can be exposed to over a specific time period (usually 15 minutes) no more than four (4) times per day. (See PEL for more information.)
	<b>TWA</b>	Most permissible exposure limits are based upon an 8-hour time weighted average (TWA). The air concentration may sometimes go above the TWA value, as long as the 8-hour average stays below. (See PEL for more information.)
<b>MSHA</b>	The Mine Safety and Health Administration in the USA.	
<b>NIOSH</b>	The National Institute for Occupational Safety and Hygiene in the United States. An organization dedicated to investigating the harmful effects of varied industrial hazards on the working population and promulgating regulations to control their harmful effects.	
<b>OSHA</b>	The Occupational Safety and Health Administration in the United States. A division of the Department of Labor charged with dealing with the health and welfare of the working population that issues guidelines and legislation to control the hazards at work.	
<b>Particulate matter (PM)</b>	Particulate matter, [also referred to as total suspended particles (TSP)] consists of tiny inhalable dust which can be man-made or natural. A wide range of particulates include the following pollutants: road dust, the burning of fossil fuel, diesel soot, environmental fires (forest or grassland), power plants, and wood smoke. These particles are a mixture of visible and microscopic solid particles and tiny liquid droplets referred to as aerosols.	
	<b>Thoracic dust</b>	PM10 is the fraction of PM containing particles that are small enough to pass the PM10 impactor (10 mm)
	<b>Respirable dust</b>	The cut-points for respirable dust are: PM4 (4 microns), PM2.5 (2.5 microns)

Term	Definition	
<b>Peak</b>	The highest level of toxic gas or oxygen reached while the unit is on.	
<b>PEL (Permissible Exposure Limit)</b>	<p>Permissible exposure limit. PEL's are a regulatory limitation to exposure used to specify the allowable exposure to a substance in the workplace and assume that the exposure takes place over an 8-hour shift in a 40-hour work week. Note that there are more stringent exposure limits for higher levels of exposure that may occur over a shorter time interval.</p> <p>There are three types of PELs:</p>	
	<b>TWA</b>	<p>Most permissible exposure limits are based upon an 8-hour time weighted average (TWA). The air concentration may sometimes go above the TWA value, as long as the 8-hour average stays below.</p> <p><i>(NOTE: This measurement is not applicable with temperature, relative humidity, or air velocity sensors.)</i></p>
	<b>Ceiling Limit</b>	<p>The maximum allowable concentration of a chemical that an employee may be exposed to. It must never be exceeded, even for an instant.</p>
<b>STEL</b>	<p>The Short Term Exposure Limit (STEL) is the maximum concentration above the time-weighted average that employees can be exposed to over a specific time period (usually 15 minutes) no more than four (4) times per day. This stands for Short Term Exposure Limit and is the maximum average concentration of a toxic gas to which an unprotected worker may be exposed over any fifteen-minute interval during a work period. The EVM calculates the STEL by compiling fifteen one-minute averages, and updates that average each minute after the initial fifteen-minute exposure. If the STEL is reached or exceeded, the alarm activates, and the STEL enunciator turns on.</p> <p>Different regulatory agencies have different acronyms for PELs: NIOSH (National Institute for Occupational Safety and Health) uses REL (Recommended Exposure Limit), and ACGIH (American Conference of Governmental Industrial Hygienists) uses TLV (Threshold Limit Value).</p> <p><i>(NOTE: This measurement is not applicable with temperature, relative humidity, or air velocity sensors.)</i></p>	
<b>Photodiode</b>	A type of photodetector that is able to convert light source into either current or voltage. With the EVM, it is used to measure the amount of light scattered from a particle cloud.	
<b>ppm/ppb</b>	Parts per million (or parts per billion) of concentration of the gas of interest in air. For example, 1 ppm signifies one part of gas to 1 million parts of air.	

Term	Definition
<b>REL (Recommended Exposure Limit)</b>	Exposure limits set by the National Institute for Occupational Safety and Health (NIOSH).
<b>Relative Humidity</b>	The relative humidity of an air-water mixture is defined as the ratio of the partial pressure of water vapor in the mixture to the saturated vapor pressure of water at a prescribed temperature. This can be calculated by dividing the temperature and dew point readings and multiplying by 100%.
<b>Relative Sensitivity</b>	Toxic and LEL sensors are calibrated to detect a specific gas. However there may be some cross-sensitivity of the sensor to other toxics or combustibles.
<b>TIME</b>	Point in time when the maximum exposure will occur from the beginning of any 8-hour period
<b>TLV</b>	Threshold limit value: the level of exposure that a worker can experience in the workplace without an unreasonable risk of disease or injury. These are not estimates of "level of risk" for different exposure levels nor do they address the different means by which a person may be exposed to a substance. TLV's are specified by ACGIH, the American Conference of Government Industrial Hygienists. TLV's are guidelines prepared by ACGIH and are solely concerned with health risk. They do not address economic considerations. TLV's are not regulatory but rather are advisory. (See PEL and TWA which are specified by OSHA).
<b>VOC (Volatile Organic Compound)</b>	A type of air pollution that is a carbon-containing chemical, which is typically vaporized at ambient temperatures. Some examples of VOCs include: biological agents (mold, dust, mites...etc.), carbon monoxide, formaldehyde, second hand tobacco smoke. On the EVM, VOCs are measured in air by using the Photoionization detection (PID) sensor.

# Appendix C

## PID sensor and correction factors tables

The following chart details approximate correction factors (or response factors) for specific concentrations of VOCs.

It is recommended, for best test results, to calibrate the PID sensor with the relevant VOC you intend to measure. If this is not possible, the factors listed in the table, provided by Ion Science, can be used when calibrating the PID sensor.

**NOTE:** These are approximate values; so, for best accuracy you should calibrate with the relevant VOC. (Please refer to Ion Science for details on linear range accuracy and table explanation.)

➤ **The table includes six columns**

1. **Gas/ VOC:** The most common name for the VOC. If you cannot find the name of your VOC of concern, refer to Ion Science’s website.
2. **Formula:** To further assist in identifying the VOC, this also is helpful in identifying its molecular weight, from which ppm measurements can be converted to say, mg/m<sup>3</sup> measurements.
3. **Response Factor:** (RF) also known as **correction factor**. Multiply the output response from the cell by the RF to provide a normalized scale of VOC concentration.
4. **Relative sensitivity:** (%) This is the inverse of the correction factor, specifying the percent response of the VOC, relative to isobutylene. If less than 100%, then the VOC is less responsive than isobutylene; if the relative sensitivity is greater than 100%, then the VOC is more responsive than isobutylene. Relative sensitivity (%) is specified the same way as cross-sensitivity for toxic gas sensors.
5. **Typical Minimum Detection Level (MDL) or Minimum Detectable Quantity (MDQ):** Typical lowest concentration that can be detected. The Mini PID HI has greater sensitivity than the Mini PID LO, so MDL’s for the Mini PID HI are much lower. The RF is measured in dry air; high humidity will reduce this factor by 10% to 20%, so the RF should be increased in high humidity’s.

**Attention:** In the table below, a Correction factor listed as “NR” indicates no response since not all VOCs or gases can be measured with a PID sensor.

**NOTE:** The “Typical minimum detection level” is listed in parts per billion in the table below. The EVM calculates VOCs in parts per million or parts per billion.

Gas/VOC	Formula (used to convert ppm measurement to mg/m <sup>3</sup> )	Correction factor	Relative sensitivity (%)	Typical PID (ppb)
Acetaldehyde	C <sub>2</sub> H <sub>4</sub> O	4.9	21	480
Acetic Acid	C <sub>2</sub> H <sub>4</sub> O <sub>2</sub>	36	3	3615
Acetic Anhydride	C <sub>4</sub> H <sub>6</sub> O <sub>3</sub>	4.0	25	400
Acetone	C <sub>3</sub> H <sub>6</sub> O	0.7	140	70
Acetonitrile	CH <sub>3</sub> CN	NR		
Acetylene	C <sub>2</sub> H <sub>2</sub>	NR		

## PID sensor and correction factors tables

Gas/VOC	Formula (used to convert ppm measurement to mg/m <sup>3</sup> )	Correction factor	Relative sensitivity (%)	Typical PID (ppb)
Acrolein	C <sub>3</sub> H <sub>4</sub> O	4.0	25	400
Acrylic Acid	C <sub>3</sub> H <sub>4</sub> O <sub>2</sub>	2.7	36	275
Acrylonitrile	C <sub>3</sub> H <sub>3</sub> N	ZR		
Allyl alcohol	C <sub>3</sub> H <sub>6</sub> O	2.1	48	200
Allyl chloride	C <sub>3</sub> H <sub>5</sub> Cl	4.5	22	450
Ammonia	H <sub>3</sub> N	8.5	12	850
Amyl acetate, n-	C <sub>7</sub> H <sub>14</sub> O <sub>2</sub>	1.8	56	180
Amyl alcohol	C <sub>5</sub> H <sub>12</sub> O	3.2	31	320
Aniline	C <sub>6</sub> H <sub>7</sub> N	0.5	200	50
Anisole	C <sub>7</sub> H <sub>8</sub> O	0.5	211	50
Arsine	AsH <sub>3</sub>	2.5	40	250
Asphalt, petroleum fumes		1.0	100	100
Benzaldehyde	C <sub>7</sub> H <sub>6</sub> O	0.9	117	85
Benzene	C <sub>6</sub> H <sub>6</sub>	0.5	200	50
Benzenethiol	C <sub>6</sub> H <sub>5</sub> SH	0.7	143	70
Benzonitrile	C <sub>7</sub> H <sub>5</sub> N	0.7	141	70
Benzyl alcohol	C <sub>7</sub> H <sub>8</sub> O	1.3	80	125
Benzyl chloride	C <sub>7</sub> H <sub>7</sub> Cl	0.6	182	55
Benzyl formate	C <sub>8</sub> H <sub>8</sub> O <sub>2</sub>	0.8	130	77
Biphenyl	C <sub>12</sub> H <sub>10</sub>	0.4	250	40
Boron trifluoride	BF <sub>3</sub>	NR		
Bromine	Br <sub>2</sub>	20	5	2000
Bromine pentafluoride	BrF <sub>5</sub>	NR		
Bromobenzene	C <sub>6</sub> H <sub>5</sub> Br	0.7	143	70
Bromochloromethane	CH <sub>2</sub> ClBr	NR		
Bromoethane	C <sub>2</sub> H <sub>5</sub> Br	5.0	20	500
Bromoethyl methyl ether	C <sub>3</sub> H <sub>7</sub> OBr	2.5	40	250
Bromoform	CHBr <sub>3</sub>	2.8	36	280
Bromopropane	C <sub>3</sub> H <sub>7</sub> Br	1.3	77	130
Bromotrifluoromethane	CF <sub>3</sub> Br	NR		
Bromoform	CHBr <sub>3</sub>	2.8	36	280
Bromopropane, 1-	C <sub>3</sub> H <sub>7</sub> Br			
Bromotrifluoromethane	CF <sub>3</sub> Br	NR		
Butadiene	C <sub>4</sub> H <sub>6</sub>	0.8	120	80
Butadiene diepoxide	C <sub>4</sub> H <sub>6</sub> O <sub>2</sub>	4.0	25	400
Butane, n-	C <sub>4</sub> H <sub>10</sub>	46	2	4600
Butanol	C <sub>4</sub> H <sub>10</sub> O	4.0	25	400
Buten-3-ol, 1-	C <sub>4</sub> H <sub>8</sub> O	1.2	87	115
Butene, 1-	C <sub>4</sub> H <sub>8</sub>	1.3	77	130
Butoxyethanol, 2-	C <sub>6</sub> H <sub>14</sub> O <sub>2</sub>	1.1	91	110
Butyl acetate, n-	C <sub>6</sub> H <sub>12</sub> O <sub>2</sub>	2.4	41	240
Butyl acrylate, n-	C <sub>7</sub> H <sub>12</sub> O <sub>2</sub>	1.5	67	150
Butyl lactate	C <sub>7</sub> H <sub>14</sub> O <sub>3</sub>	2.5	40	250
Butyl mercaptan	C <sub>4</sub> H <sub>10</sub> S	0.5	185	50



## PID sensor and correction factors tables

Gas/VOC	Formula (used to convert ppm measurement to mg/m <sup>3</sup> )	Correction factor	Relative sensitivity (%)	Typical PID (ppb)
Butylamine, 2-	C4H11N	0.9	111	90
Butylamine, n-	C4H11N	1.0	100	100
Camphene	C10H16	0.5	222	45
Carbon dioxide	CO2	ZR	-	-
Carbon disulfide	CS2	1.4	71	140
Carbon monoxide	CO	NR	-	-
Carbon tetrabromide	CBr4	3.0	33	300
Carbon tetrachloride	CCl4	NR	-	-
Carbonyl sulphide	COS	NR	-	-
Carvone, R-	C10H14O	C10H14O	100	100
Chlorine	Cl2	NR	-	-
Chlorine dioxide	ClO2	1.0	100	100
Chlorine trifluoride	ClF3	NR	-	-
Chloro-1,1,1,2-tetrafluoroethane	C2HClF4	NR	-	-
Chloro-1,1,1-trifluoroethane, 2-	C2H2ClF3	NR	-	-
Dibromochloromethane	CHBr2Cl	10.0	10	1000
Dibromodifluoromethane	CF2Br2 ZR	NR	-	-
Dibromoethane 1,2-	C2H4Br2	2.0	50	200
Dibromotetrafluoroethane, 1,2-	C2F4Br2	NR	-	-
Dibutyl hydrogen phosphate	HC8H18 PO4	4.0	25	400
Dichloro-1,1,1- trifluoroethane, 2,2-	C2HCl2F3	NR	-	-
Dichloro-1,1- difluoroethane, 1,2-	C2H2Cl2F2	NR	-	-
Dichloro-1,2,2- trifluoroethane, 1,2-	C2HCl2F3	NR	-	-
Dichloro-1,2- difluoroethane, 1,2-	C2H2Cl2F2	NR	-	-
Dichloro-1-fluoroethane, 1,1-	C2H3Cl2F	NR	-	-
Dichloro-1-fluoroethane, 1,1-	C2H3Cl2F	NR	-	-
Dichloro-1-fluoroethane, 1,2-	C2H3Cl2F	NR	-	-
Dichloro-1-propene	C3H4Cl2	1.4	70	140
Dichloro-2,2- difluoroethane, 1,1-	C2H2Cl2F2	NR	-	-
Dichloroacetylene	C2Cl2	5.0	20	500
Dichlorobenzene o-	C6H4Cl2	0.5	200	50
Dichlorodifluoromethane	CCl2F2	NR	-	-
Dichloroethane 1,2-	C2H4Cl2	NR	-	-
Dichloroethane, 1,1-	C2H2Cl2	NR	-	-
Dichloroethene, 1,1-	C2H2Cl2	1.0	105	100
Dichloroethene, cis-1,2-	C2H2Cl2	0.8	125	80
Dichloroethene, trans-1,2-	C2H2Cl2	0.7	143	70
Dichloroethylene 1,2-	C2H2Cl2	0.8	133	75
Difluoromethane	CH2F2	NR	-	-

## PID sensor and correction factors tables

Gas/VOC	Formula (used to convert ppm measurement to mg/m <sup>3</sup> )	Correction factor	Relative sensitivity (%)	Typical PID (ppb)
Dihydrogen selenide	H <sub>2</sub> Se	1.0	100	100
Dihydroxybenzene, 1,2	C <sub>6</sub> H <sub>6</sub> O <sub>2</sub>	1.0	100	100
Diisobutylene	C <sub>8</sub> H <sub>16</sub>	0.6	156	60
Diisopropyl ether	C <sub>6</sub> H <sub>14</sub> O	0.7	150	70
Diisopropylamine	C <sub>6</sub> H <sub>15</sub> N	0.7	140	70
Diketene	C <sub>4</sub> H <sub>4</sub> O <sub>2</sub>	2.2	45	220
Dimethoxymethane	C <sub>3</sub> H <sub>8</sub> O <sub>2</sub>	1.4	71	140
Dimethyl cyclohexane, 1,2-	C <sub>8</sub> H <sub>16</sub>	1.1	95	105
Dimethyl disulphide	C <sub>2</sub> H <sub>6</sub> S <sub>2</sub>	0.2	435	23
Dimethyl ether	C <sub>2</sub> H <sub>6</sub> O	1.3	80	130
Dimethyl phthalate	C <sub>10</sub> H <sub>10</sub> O <sub>4</sub>	1.0	100	100
Dimethyl sulphate	C <sub>2</sub> H <sub>6</sub> O <sub>4</sub> S	NR	-	-
Dimethyl sulphide	C <sub>2</sub> H <sub>6</sub> S	0.5	200	50
Dimethylacetamide N,N-	C <sub>4</sub> H <sub>9</sub> NO	1.3	75	130
Dimethylamine	C <sub>2</sub> H <sub>7</sub> N	1.4	70	140
Dimethylaminoethanol	C <sub>4</sub> H <sub>11</sub> NO	1.5	70	150
Dimethylaniline, NN-	C <sub>8</sub> H <sub>11</sub> N	0.6	167	60
Dimethylbutyl acetate	C <sub>8</sub> H <sub>16</sub> O <sub>2</sub>	1.6	60	160
Dimethylethylamine, NN-	C <sub>4</sub> H <sub>11</sub> N	0.8	125	80
Dimethylformamide	C <sub>3</sub> H <sub>7</sub> NO	0.9	110	90
Dimethylheptan-4-one, 2,6-	C <sub>9</sub> H <sub>18</sub> O	0.8	125	80
Dimethylhydrazine, 1,1-	C <sub>2</sub> H <sub>8</sub> N <sub>2</sub>	1.0	100	100
Dinitrobenzene, m-	C <sub>6</sub> H <sub>4</sub> N <sub>2</sub> O <sub>4</sub>	3.0	33	300
Dinitrobenzene, o-	C <sub>6</sub> H <sub>4</sub> N <sub>2</sub> O <sub>4</sub>	NR	-	-
Dinitrobenzene, p-	C <sub>6</sub> H <sub>4</sub> N <sub>2</sub> O <sub>4</sub>	5.0	20	500
Dinonyl phthalate	C <sub>26</sub> H <sub>42</sub> O <sub>4</sub>	1.0	100	100
Dioxane 1,2-	C <sub>4</sub> H <sub>8</sub> O <sub>2</sub>	1.5	67	150
Dioxane 1,4-	C <sub>4</sub> H <sub>8</sub> O <sub>2</sub>	1.5	67	150
Dipentene	C <sub>10</sub> H <sub>16</sub>	0.9	110	90
Diphenyl ether	C <sub>12</sub> H <sub>10</sub> O	0.8	125	80
Disulphur decafluoride	S <sub>2</sub> F <sub>10</sub>	NR	-	-
Disulphur dichloride	S <sub>2</sub> Cl <sub>2</sub>	3.0	33	300
Di-tert-butyl-p-cresol	C <sub>11</sub> H <sub>16</sub> O	1.0	100	100
Divinylbenzene	C <sub>10</sub> H <sub>10</sub>	0.4	250	40
Dodecanol	C <sub>12</sub> H <sub>26</sub> O	0.9	110	90
Enflurane	C <sub>4</sub> H <sub>2</sub> F <sub>5</sub> ClO	NR	-	-
Epichlorohydrin	C <sub>3</sub> H <sub>5</sub> ClO	8.0	15	800
Epoxypropyl isopropyl ether, 2,3-	C <sub>6</sub> H <sub>12</sub> O <sub>2</sub>	1.1	90	110
Ethane	C <sub>2</sub> H <sub>6</sub>	NR	-	-
Ethanol	C <sub>2</sub> H <sub>6</sub> O	8.7	10	870
Ethanolamine	C <sub>2</sub> H <sub>7</sub> NO	3.0	33	300
Ethoxy-2-propanol, 1-	C <sub>5</sub> H <sub>10</sub> O <sub>2</sub>	2.0	50	200
Ethoxyethanol, 2-	C <sub>4</sub> H <sub>10</sub> O <sub>2</sub>	29.8	3	3000
Ethoxyethyl acetate, 2-	C <sub>6</sub> H <sub>12</sub> O <sub>3</sub>	3.0	33	300
Ethyl (S)-(-)-lactate	C <sub>5</sub> H <sub>10</sub> O <sub>3</sub>	3.0	33	300
Ethyl acetate	C <sub>4</sub> H <sub>8</sub> O <sub>2</sub>	3.6	28	360
Ethyl acrylate	C <sub>5</sub> H <sub>8</sub> O <sub>2</sub>	2.0	50	200
Ethyl amine	C <sub>2</sub> H <sub>7</sub> N	1.0	100	100

## PID sensor and correction factors tables

Gas/VOC	Formula (used to convert ppm measurement to mg/m <sup>3</sup> )	Correction factor	Relative sensitivity (%)	Typical PID (ppb)
Ethyl benzene	C8H10	0.5	185	50
Ethyl butyrate	C6H12O2	1.0	105	100
Ethyl chloroformate	C3H5O2Cl	80	1	8300
Ethyl cyanoacrylate	C6H7O2N	1.5	67	150
Ethyl decanoate	C12H24O2	1.8	56	180
Ethyl formate	C3H6O2	30	3	3000
Ethyl hexanoate	C8H16O2	2.6	38	260
Ethyl hexanol, 2	C8H18O	1.5	67	150
Ethyl hexyl acrylate, 2-	C11H20O2	1.0	100	100
Ethyl mercaptan	C2H6S	0.7	145	70
Ethyl octanoate	C10H20O2	2.3	40	230
Ethylene	C2H4	8.0	13	800
Ethylene dinitrate	C2H4O6N2	NR	-	-
Ethylene glycol	C2H6O2	20.0	5	2000
Ethylene oxide	C2H4O	15.0	7	1500
Ferrocene	C10H10Fe	0.8	125	80
Fluorine	F2	NR	-	-
Fluoroethane	C2H5F	NR	-	-
Fluoromethane	CH3F	NR	-	-
Formaldehyde	CH2O	NR	-	-
Formamide	CH3ON	2.0	50	200
Formic acid	CH2O2	NR	-	-
Furfural	C5H4O2	1.4	70	140
Furfuryl alcohol	C5H6O2	2.0	50	200
Gasoline vapors		1.1	95	105
Germane	GeH4	10.0	10	1000
Glutaraldehyde	C5H8O2	0.9	111	90
Halothane	CF3CHBrCl	NR	-	-
Helium	He	NR	-	-
Heptan-2-one	C7H14O	0.7	140	70
Heptan-3-one	C7H14O	0.8	133	75
Heptane n-	C7H16	2.1	50	200
Hexachloroethane	C2Cl6	NR	-	-
Hexafluoroethane	C2F6	NR	-	-
Hexamethyldisilazane, 1,1,1,3,3,3-	C6H19NSi2	1.0	100	100
Hexamethyldisiloxane	C6H18OSi2	0.3	350	30
Hexan-2-one	C6H12O	0.8	125	80
Hexane n-	C6H14	4.2	25	420
Hexene, 1-	C6H12	0.9	110	90
Hydrazine	H4N2	3.0	33	300
Hydrazoic acid	HN3	NR	-	-
Hydrogen	H2	NR	-	-
Hydrogen bromide	HBr	NR	-	-
Hydrogen chloride	HCl	NR	-	-
Hydrogen cyanide	HCN	NR	-	-
Hydrogen fluoride	HF	NR	-	-
Hydrogen peroxide	H2O2	4.0	25	400
Hydrogen sulfide	H2S	4.0	25	400

## PID sensor and correction factors tables

Gas/VOC	Formula (used to convert ppm measurement to mg/m <sup>3</sup> )	Correction factor	Relative sensitivity (%)	Typical PID (ppb)
Hydroquinone	C6H6O2	0.8	125	80
Hydroxypropyl acrylate 2-	C6H10O3	1.5	67	150
Iminodi(ethylamine) 2,2-	C4H13N3	0.9	110	90
Iminodiethanol 2,2'-	C4H11NO2	1.6	60	160
Indene	C9H8	0.5	220	50
Iodine	I2	667	1	15
Iodoform	CHI3	1.5	67	150
Iodomethane	CH3I	0.4	250	40
Isoamyl acetate	C7H14O2	1.6	8	160
Isobutane	C4H10	8.0	40	800
Isobutanol	C4H10O	3.5	30	350
Isobutyl acetate	C6H12O2	2.3	45	230
Isobutyl acrylate	C7H12O2	1.3	80	130
Isobutylene	C4H8	1.0	100	100
Isobutyraldehyde	C4H8O	1.2	80	120
Isodecanol	C10H22O	0.9	110	90
Isoflurane	C3H2ClF5O	NR	-	-
Isononanol	C9H20O	1.5	67	150
Isooctane	C8H18	1.1	90	100
Isooctanol	C8H18O	1.7	60	170
Isopentane	C5H12	6.0	20	600
Isophorone	C9H14O	0.8	133	75
Isoprene	C5H8	0.7	140	70
Isopropanol	C3H8O	4.4	20	440
Isopropyl acetate	C5H10O2	2.2	50	220
Isopropyl chloroformate	C4H7O2Cl	1.6	60	160
Jet Fuel JP-4		0.8	133	75
Jet Fuel JP-5		0.7	150	60
Jet Fuel JP-8		0.7	150	60
Kerosene		0.8	120	90
Ketene	C2H2O	3.0	33	300
Liquefied petroleum gas		NR	-	-
Maleic anhydride	C4H2O3	2.0	50	200
Mercaptoacetic acid	C2H4O2S	1.0	100	100
Mercury	Hg	NR	-	-
Mercury alkyls		NR	-	-
Mesitylene	C9H12	0.3	300	30
Methacrylic acid	C4H6O2	2.3	40	230
Methacrylonitrile	C4H5N	5.0	20	500
Methane	CH4	NR	-	-
Methanol	CH4O	200	1	20000
Methoxyethanol, 2-	C3H8O2	2.7	40	270
Methoxyethoxyethanol, 2-	C5H12O3	1.4	70	140
Methoxymethylethoxy-2-propanol	C7H16O3	1.3	80	130
Methoxypropan-2-ol	C4H10O2	3.0	33	300
Methoxypropyl acetate	C6H12O3	1.2	80	120
Methyl acetate	C3H6O2	5.2	20	500

## PID sensor and correction factors tables

Gas/VOC	Formula (used to convert ppm measurement to mg/m <sup>3</sup> )	Correction factor	Relative sensitivity (%)	Typical PID (ppb)
Methyl acrylate	C4H6O2	3.4	30	340
Methyl bromide	CH3Br	1.9	50	190
Methyl cyanoacrylate	C5H5O2N	5.0	20	500
Methyl ethyl ketone	C4H8O	0.8	130	80
Methyl ethyl ketone peroxides	C8H18O2	0.8	125	80
Methyl formate	C2H4O2	NR	-	-
Methyl isobutyl ketone	C6H12O	0.8	125	80
Methyl isocyanate	C2H3NO	NR	-	-
Methyl isothiocyanate	C2H3NS	0.6	167	60
Methyl mercaptan	CH4S	0.7	140	70
Methyl methacrylate	C5H8O2	1.6	60	160
Methyl propyl ketone	C5H10O	0.8	130	80
Methyl salicylate	C8H8O3	1.2	80	120
Methyl sulphide	C2H6S	0.5	200	50
Methyl t-butyl ether	C5H12O	0.8	125	80
Methyl-2-propen-1-ol, 2-	C4H8O	1.1	90	100
Methyl-2-pyrrolidinone, N-	C5H9NO	0.9	110	90
Methyl-4,6-dinitrophenol, 2-	C7H6N2O5	3.0	33	300
Methyl-5-hepten-2-one, 6-	C8H14O	0.8	125	80
Methylamine	CH5N	1.4	70	140
Methylbutan-1-ol, 3-	C5H12O	3.4	30	340
Methylcyclohexane	C7H14	1.1	90	110
Methylcyclohexanol, 4-	C7H14O	2.4	40	240
Methylcyclohexanone 2-	C7H12O	1.0	100	100
Methylheptan-3-one, 5-	C8H16O	0.8	133	75
Methylhexan-2-one, 5-	C7H14O	0.8	133	75
Methylhydrazine	CH6N2	1.3	80	130
Methyl-N-2,4, 6-tetranitroaniline, N-	C7H5N5O8	3.0	33	300
Methylpent-3-en-2-one, 4-	C6H10O	0.7	140	70
Methylpentan-2-ol, 4-	C6H14O	2.8	40	280
Methylpentane-2,4-diol, 2-	C6H14O2	4.0	25	400
Methylpropan-2-ol, 2-	C4H10O	3.5	30	350
Methylstyrene	C9H10	0.5	200	50
Mineral oil		0.8	125	80
Mineral spirits		0.8	125	80
Naphthalene	C10H8	0.4	230	45
Nitric oxide	NO	8.0	15	800
Nitroaniline	C6H6N2O2	0.8	125	80
Nitrobenzene	C6H5NO2	1.7	60	170
Nitroethane	C2H5NO2	NR	-	-
Nitrogen dioxide	NO2	10.0	10	1000
Nitrogen trichloride	NCI3	1.0	100	100
Nitrogen trifluoride	NF3	NR	-	-
Nitromethane	CH3NO2	NR	-	-
Nitropropane, 1-	C3H7NO2	NR	-	-
Nitropropane, 2-	C3H7NO2	NR	-	-
Nitrous oxide	N2O	NR	-	-
Nonane, n-	C9H20	1.3	80	130

## PID sensor and correction factors tables

Gas/VOC	Formula (used to convert ppm measurement to mg/m <sup>3</sup> )	Correction factor	Relative sensitivity (%)	Typical PID (ppb)
Norbornadiene, 2,5-	C7H8	0.6	167	60
Octachloronaphthalene	C10Cl8	1.0	100	100
Octane, n-	C8H18	1.6	60	160
Octene, 1-	C8H16	0.7	140	70
Oxalic acid	C2H2O4	NR	-	-
Oxalonitrile	C2N2	NR	-	-
Oxydiethanol 2,2-	C4H10O3	4.0	25	400
Oxygen	O2	NR	-	-
Ozone	O3	NR	-	-
Paraffin wax, fume		1.0	100	100
Paraffins, normal		1.0	105	100
Pentacarbonyl iron	FeC5O5	1.0	100	100
Pentachloroethane	C2HCl5	NR	-	-
Pentachlorofluoroethane	C2Cl5F	NR	-	-
Pentafluoroethane	C2HF5	NR	-	-
Pentan-2-one	C5H10O	0.8	125	80
Pentan-3-one	C5H10O	0.8	125	80
Pentandione, 2,4-	C5H8O2	0.8	133	75
Pentane, n-	C5H12	7.9	15	800
Peracetic acid	C2H4O3	2.0	50	200
Perchloryl fluoride	ClO3F	NR	-	-
Perfluoropropane	C3F8	NR	-	-
Petroleum ether		0.9	110	90
Phenol	C6H6O	1.2	85	120
Phenyl propene, 2-	C9H10	0.4	230	45
Phenyl-2,3-epoxypropyl ether	C9H10O2	0.8	125	80
Phenylenediamine	C6H8N2	0.6	167	60
Phosgene	COCl2	NR	-	-
Phosphine	PH3	2.0	50	200
Picoline	C6H7N	0.9	110	90
Pinene, alpha	C10H16	0.3	315	30
Pinene, beta	C10H16	0.3	315	30
Piperidine	C5H11N	0.9	110	90
Piperylene	C5H8	0.7	150	67
Prop-2-yn-1-ol	C3H4O	1.3	80	130
Propan-1-ol	C3H8O	4.8	20	480
Propane	C3H8	NR	-	-
Propane-1,2-diol, total	C3H8O2	10.0	50	1000
Propene	C3H6	1.4	70	140
Propionaldehyde	C3H6O	1.7	60	169
Propionic acid	C3H6O2	8.0	15	800
Propyl acetate, n-	C5H10O2	2.5	40	250
Propylene dinitrate	C3H6N2O6	NR	-	-
Propylene oxide	C3H6O	7.0	15	700
Propyleneimine	C3H7N	1.3	80	130
Pyridine	C5H5N	0.8	133	75
Pyridylamine 2-	C5H6N2	0.8	125	80
Silane	SiH4	NR	-	-

## PID sensor and correction factors tables

Gas/VOC	Formula (used to convert ppm measurement to mg/m <sup>3</sup> )	Correction factor	Relative sensitivity (%)	Typical PID (ppb)
Sodium fluoroacetate	C2H2O2FNa	NR	-	-
Styrene	C8H8	0.4	230	50
Sulphur dioxide	SO2	NR	-	-
Sulphur hexafluoride	SF6	NR	-	-
Sulphur tetrafluoride	SF4	NR	-	-
Sulphuric acid	H2SO4	NR	-	-
Sulphuryl fluoride	SO2F2	NR	-	-
Terphenyls	C18H14	0.6	167	60
Terpinolene	C10H16	0.5	210	50
Tert-butanol	C4H10O	2.6	40	260
Tetrabromoethane, 1,1,2,2-	C2H2Br4	2.0	50	200
Tetracarbonylnickel	NiC4O4	1.0	100	100
Tetrachloro-1,2-difluoroethane,	C2Cl4F2	NR	-	-
Tetrachloro-1-fluoroethane, 1,1,2,2-	C2HCl4F	NR	-	-
Tetrachloro-2,2-difluoroethane	C2Cl4F2	NR	-	-
Tetrachloro-2-fluoroethane	C2HCl4F	NR	-	-
Tetrachloroethane, 1,1,1,2-	C2H2Cl4	NR	-	-
Tetrachloroethane, 1,1,2,2-	C2H2Cl4	NR	-	-
Tetrachloroethylene	C2Cl4	0.7	140	70
Tetrachloronaphthalenes, all isomers	C10H4Cl4	1.0	100	100
Tetraethyl orthosilicate	C8H20O4Si	2.0	50	200
Tetraethyllead	C8H20Pb	NR	-	-
Tetrafluoroethane, 1,1,1,2-	C2H2F4	NR	-	-
Tetrafluoroethane, 1,1,2,2-	C2H2F4	NR	-	-
Tetrafluoroethylene	C2F4	1.0	100	100
Tetrafluoromethane	CF4	NR	-	-
Tetrahydrofuran	C4H8O	1.6	65	150
Tetramethyl orthosilicate	C4H12O4Si	NR	-	-
Tetramethyl succinonitrile	C8H12N2	1.0	100	100
Therminol		1.0	100	100
Thionyl chloride	SOCl2	NR	-	-
Toluene	C7H8	0.5	200	50
Toluene-2,4-diisocyanate	C9H6N2O2	1.6	60	160
Toluenesulphonyl chloride, p-	C7H7SO2 Cl	3.0	33	300
Toluidine, o-	C7H9N	0.5	200	50
Tributyl phosphate	C12H27O4P	5.0	20	500
Tributylamine	C12H27N	1.0	100	100
Trichloro-1,1- difluoroethane, 1,2,2-	C2HCl3F2	NR	-	-
Trichloro-1,2-difluoroethane, 1,1,2-	C2HCl3F2	NR	-	-
Trichloro-2,2-difluoroethane, 1,1,1-	C2HCl3F2	NR	-	-
Trichloro-2-fluoroethane, 1,1,2-	C2H2Cl3F	NR	-	-
Trichlorobenzene 1,2,4-	C6H3Cl3	0.6	180	50
Trichloroethane, 1,1,1-	C2H3Cl3	NR	-	-
Trichloroethane, 1,1,2-	C2H3Cl3	NR	-	-
Trichloroethylene	C2HCl3	0.7	150	65

## PID sensor and correction factors tables

Gas/VOC	Formula (used to convert ppm measurement to mg/m <sup>3</sup> )	Correction factor	Relative sensitivity (%)	Typical PID (ppb)
Trichlorofluoromethane	CCl <sub>3</sub> F	NR	-	-
Trichloronitromethane	CCl <sub>3</sub> NO <sub>2</sub>	NR	-	-
Trichlorophenoxyacetic acid, 2,4,5-	C <sub>8</sub> H <sub>5</sub> O <sub>3</sub> Cl <sub>3</sub>	1.0	100	100
Trichloropropane 1,2,3-	C <sub>3</sub> H <sub>5</sub> Cl <sub>3</sub>	NR	-	-
Trichlorotrifluoroethane, 1,1,1-	C <sub>2</sub> Cl <sub>3</sub> F <sub>3</sub>	NR	-	-
Trichlorotrifluoroethane, 1,1,2-	C <sub>2</sub> Cl <sub>3</sub> F <sub>3</sub>	NR	-	-
Triethylamine	C <sub>6</sub> H <sub>15</sub> N	0.9	110	90
Trifluoroethane, 1,1,1-	C <sub>2</sub> H <sub>3</sub> F <sub>3</sub>	NR	-	-
Trifluoroethane, 1,1,2-	C <sub>2</sub> H <sub>3</sub> F <sub>3</sub>	NR	-	-
Trifluoroethanol, 2,2,2-	C <sub>2</sub> H <sub>3</sub> F <sub>3</sub> O	NR	-	-
Trifluoromethane	CHF <sub>3</sub>	NR	-	-
Trimethylamine	C <sub>3</sub> H <sub>9</sub> N	0.5	200	50
Trimethylbenzene mixtures	C <sub>9</sub> H <sub>12</sub>	0.3	300	35
Trimethylbenzene, 1,3,5-	C <sub>9</sub> H <sub>12</sub>	0.3	300	35
Trinitrotoluene 2,4,6-	C <sub>7</sub> H <sub>5</sub> N <sub>3</sub> O <sub>6</sub>	NR	-	-
Turpentine	C <sub>10</sub> H <sub>16</sub>	0.6	167	60
TVOC		1.0	100	100
Undecane, n-	C <sub>11</sub> H <sub>24</sub>	0.9	110	100
Vinyl acetate	C <sub>4</sub> H <sub>6</sub> O <sub>2</sub>	1.1	90	110
Vinyl bromide	2 C <sub>2</sub> H <sub>3</sub> Br	1.0	100	100
Vinyl chloride	C <sub>2</sub> H <sub>3</sub> Cl	2.1	50	200
Vinyl-2-pyrrolidinone, 1-	C <sub>6</sub> H <sub>9</sub> NO	0.9	110	90
Xylene mixed isomers	C <sub>8</sub> H <sub>10</sub>	0.4	230	240
Xylene, m-	C <sub>8</sub> H <sub>10</sub>	0.4	230	50
Xylene, o-	C <sub>8</sub> H <sub>10</sub>	0.6	167	60
Xylene, p-	C <sub>8</sub> H <sub>10</sub>	0.6	180	50
Xylidine, all	C <sub>8</sub> H <sub>11</sub> N	0.7	140	70



# Appendix D

## Frequently Asked Questions (FAQs)

### Particulate Measurements

Question	Response/Solution
<p>1. What do the impactor cut-points represent?</p>	<p>Depending on the environment and the industrial processes (such as sanding, cutting, crushing, grinding, and transportation), the type and size of the particulates will impact the human body in different areas, affecting the nasal, throat, and/or lung area.</p> <p>The impactor cut-points represent the particle size you will be sampling. Inhalable dust is 100 microns and smaller. This dust is usually filtered through the hairs and membranes in your sinuses. 10 microns and smaller is thoracic, and dust in the 4 to 10 micron size can get caught in you windpipe and other regions. 4 microns and smaller is respirable and this is what causes concerns and the need for PM4.</p>
<p>2. How does the impactor function when there is a build-up of particulates (in a conical shaped pyramid)?</p>	<p>When the build-up of particulates form a shaped pyramid, it will not measure appropriately. This is the indicator to clean the impactor.</p> <p><b>The reason:</b> As with any impactor-type filter, this filter relies on the larger particles being unable to “turn the corner”, striking the greased-plate and being filtered out of the stream. As the pyramid builds up more and more, particles will begin to gently slide on past the impactor plate. We provide a fourth inlet which can be connected to a cyclone if extreme environments and/or longer run-times are needed. <b>NOTE: the impactors are designed to work correctly ONLY at 1.67 L/min.</b></p>
<p>3. Is it possible to do an inhalable or respirable gravimetric sample?</p>	<p>Yes, it is possible to do inhalable and respirable gravimetric sampling. This can be accomplished through the "dial-in" impactors or with a cyclone in the open (4th) hole on the turret. This hole is used for zeroing the instrument as well as allowing the use of a cyclone in that inlet port.</p>
<p>4. How do I set the cut-points for particulate measurements?</p>	<p>Turn the turret until the appropriate setting is displayed on the instrument's screen. (Settings include: PM2.5, PM4, PM10, and PM. <b>NOTE: PM is unfiltered particulate collector and allows all sizes through the dust path for collection and measurement.</b>)</p>
<p>5. How often do you need to apply the grease to the impactors?</p>	<p>The impactors require periodic cleaning (and greasing) which is dependent on the density of air particulates floating in the intended environment. A relatively dusty environment (approximately under 10mg/m<sup>3</sup>) should last an entire day. When dust pyramids form on impactor plates this signifies they require cleaning and greasing. Refer to Impactor Care Section and the Optical Engine Maintenance and Cleaning Section in <a href="#">Chapter 7</a> for cleaning details.</p>

Question	Response/Solution
6. How do I know when to clean the optical engine/photometer?	The following conditions may occur: (1) If calibrating the particulate (PM) sensor and it will not zero, this indicates the optical engine will need cleaning. (2) The instrument is exposed to oily or wet mists. (3) The readings are falling lower and lower indicating the mirror is dirty. (Please see <a href="#">Chapter 7</a> for details on cleaning and maintenance.)
7. How is the EVM-7 and EVM-3 calibrated in the factory?	Each instrument is factory calibrated to the ISO 12103-A2 Fine (Arizona Road Dust). A factory calibration is conducted with a “golden” instrument that is calibrated using a certifiable gravimetric sample. TSI Incorporated recommends a yearly factory calibration.
8. Do I need to calibrate before I run real-time particulate measurements?	Yes, it is recommended to perform a zero calibration in each environment you will be measuring particulates. To perform a zero calibration, ensure that the zero filter/HEPA filter is attached, the impactor is well greased, and the turret is set to PM. Then, using the keypad navigate to Calibrate>PM screen and perform a zero calibration (see <a href="#">Chapter 4</a> for specific details). <b>NOTE:</b> A zero calibration may be used when performing area-survey monitoring. However, if you are testing in accordance to NIOSH0600 or if you want to measure the actual mass concentration in a specific environment, you would run a gravimetric calibration to determine a correction factor referenced to the ARD.
9. When test collecting real-time particulate measurements for a period of time, how do I verify the calibration?	First, ensure you performed a zero calibration prior to your testing (with the supplied Zero/HEPA filter). Run your real-time particulate measurements. Then, perform a Calibration (PM) Verify via the Verify soft key/quick key (see <a href="#">Chapter 4</a> for specific details.)
10. What if I need to calibrate particulates in accordance to NIOSH0600?	A gravimetric calibration is performed. The steps below outline a gravimetric calibration (see <a href="#">Chapter 4</a> for specific details).
11. How many correction factors can be stored on the monitor and in DMS?	The EVM supports 8 different particulate matter (PM) configurations/profiles with customized name settings and user correction factor settings. See <a href="#">Chapter 3</a> for instrument profile set-up or <a href="#">Chapter 6</a> for DMS set-up for more details.
12. What if I want to enter in the correction factor after running/logging particulate measurements?	You can adjust/change the correction factor in Detection Management Solutions (DMS) after the session has been downloaded. The Dust Correction Override feature is a type of scaling factor that will re-calculate the data instantly in the chart or graph you are viewing. ( <b>NOTE:</b> The Dust Correction Override field is displayed in the General Data panel and is applied to the dust measurements in the logged data chart/table when dust is the selected parameter. To apply, select the dust override icon  and add a new value.)

## Gravimetric Sample (optional for particulate calibration)

Question	Response/Solution
1. What is the backpressure capabilities? (inches/water column)	>= 15 inches of water @ 1.67 L/min
2. What type of cassettes can be installed?	Both <b>25-mm and 37-mm cassettes</b> can be used in the EVM monitor.
3. How do you replace the filters (which are supplied in the kit)?	The cassettes are separated using a “larger”-sized screwdriver. The backing should always remain in the cassette (white, thin cardboard-like circular disc) and the filter is placed on top of the backing. An EVM-7 or EVM-3 is shipped with 10-pack of replaceable filters. (Filters can be ordered in 5-packs via TSI, see TSI contact section.)
4. Can we run the unit without a cassette?	The monitor should <b>not</b> be run without a cassette. The monitor is installed with a pump protection filter cassette. As its name indicates, it protects the pump from particulate matter. This cassette or a new cassette (if performing a gravimetric sample) should <b>always</b> be installed. It should be noted that the pump protection filter cassette will periodically need to be cleaned or replaced.
5. Does TSI offer cassettes?	TSI offers a 5-pack of 37-mm gravimetric cassettes (for pump protection). Order Part Number 074-076-5. TSI also offers a 10-pack, order Part Number 074-090; However, TSI does not offer any other filters for special testing.

## Toxic Sensor Measurements

Question	Response/Solution		
1. How many toxics can I measure simultaneously?	One toxic sensor (which is located in the left position of the housing); in addition to PID (middle position) and CO <sub>2</sub> (right position).		
2. What's the life expectancy and warranty on the various Sensors?	Sensor Type	Life expectancy	Warranty
	Particulates sensor	5000 hours (for the laser photo-meter)	1 year
	CO <sub>2</sub> sensor	5 years	1 year
	PID sensor (for measuring VOCs)	2000 hours in clean air environment (replaceable bulb and grid)	1 year
	Carbon Monoxide (CO)	2 years	2 years
	Chlorine (CL <sub>2</sub> )	2 years	1 year
	Ethylene Oxide (EtO)	2 years	1 year
	Hydrogen Cyanide (HCN)	2 years	1 year
	Hydrogen Sulfide (H <sub>2</sub> S)	2 years	2 years
	Nitrogen Dioxide (NO <sub>2</sub> )	2 years	2 years
	Nitric Oxide (NO)	2 years	2 years
	Oxygen (O <sub>2</sub> )	2 years	1 year
Sulphur Dioxide (SO <sub>2</sub> )	2 years	2 years	

## Pump/Airflow Measurements

Question	Response/Solution
1. How is the flow rate controlled?	There is a differential pressure sensor on the PC board that is used to measure the pressure drop across the orifice above. The reason is to maintain the correct pressure drop across the orifice.
2. Will the pump always regulate?	The pump tries to maintain 1.67 L/min flow rate. When the flow rate is not maintained, the message "Pump unable to regulate" will appear on the screen's display. <b>Solution: (1)</b> the gravimetric cassette may need to be replaced, <b>(2)</b> detach any external devices (such as a cyclone).
3. How often do we need to calibrate the pump?	TSI recommends an annual factory calibration. If the user has an accurate flow meter, such as a bubble-flow meter, the user may perform more periodic pump calibrations.
4. How do we calibrate the pump?	An accurate flow meter (such as a primary standard calibrator) and tubing is required to perform this calibration. The primary standard calibrator tubing is inserted in the air flow outlet (located at the back of the housing). Navigate to the <b>CALIBRATION\FLOW RT</b> screen. Press the <b>CAL</b> quick key and then the <b>START</b> quick key. Adjust the flow rate (using the up and down arrow keys) to 1.67 L/min and then confirm by pressing the <b>SAVE</b> quick key. It should be noted that in order for the impactors to work properly the flow rate <b>must be</b> adjusted to 1.67 L/min.
5. Can we adjust the flow rate?	The flow rate can be adjusted (see the "How do we calibrate the pump?" question above). It should be noted that in order for the impactors to work properly the flow rate <b>MUST</b> be adjusted to 1.67 L/min.
6. How can we verify the constant flow?	Using an accurate flow meter (or primary standard), calibrate before your run/logging and verify after to ensure a constant flow rate. <b>NOTE:</b> <i>The primary standard calibrator tubing is inserted in the air flow outlet (located at the back of the monitor).</i>

## Digital Output (using stereo plug & diagram)

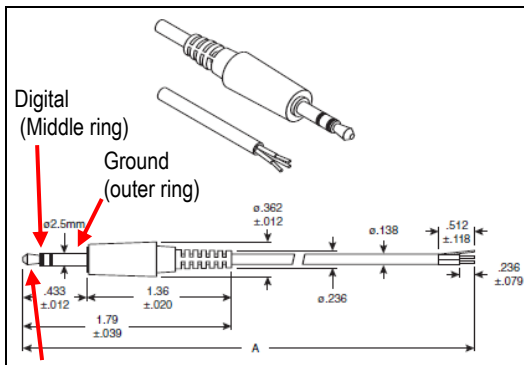
Question	Response/Solution
<p>1. How do I access my analog or digital out connection?</p>	<p>Using a Stereo plug (as the example shows below), connect the analog tip of the plug to the analog/digital output port (Figure A). Use Diagrams below to connect external device. (Please contact TSI technical support for stereo plug details.) (Figure B).</p>
<div style="display: flex; align-items: center;">  <div style="margin-left: 20px;"> <p>Input/Output Port</p> <p>User connector end (e.g. for a chart recorder or for a light notification device)</p> </div> </div> <p style="text-align: center;"><b>Figure A: Analog/Digital Output</b></p>	<div style="display: flex; align-items: center;">  </div> <p style="text-align: center;"><b>Figure B: Stereo plug</b></p>
<p><b>Stereo Plug Specifications (See "Figure B" above)</b></p>	
<b>Type:</b>	2.5-mm Stereo Plug, Stripped & Tinned, Shielded
<b>Temperature:</b>	60°C
<b>Voltage Rating:</b>	24 VDC
<b>Conductor:</b>	26 AWG (.12 mm x 10) Copper Wire with PVC Jacket
<b>Shield:</b>	.12 mm x 30 Wrapped Copper Wire
<b>Plug:</b>	Brass
<b>Tip Insulator:</b>	ABS
<b>Body &amp; Jacket:</b>	PVC
<b>Wire Color Coding:</b>	Plug Tip (White), Ring (Red), Sleeve (Shielding)

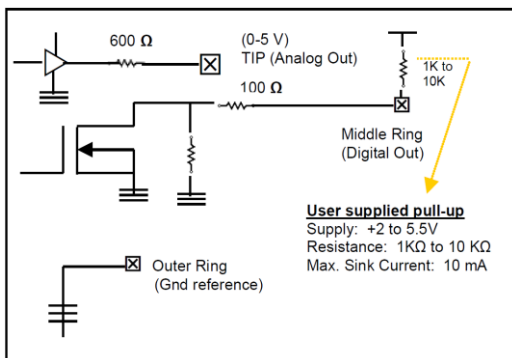

## PID Questions (for Volatile organic compound measurements)

Question	Response/Solution
1. Measuring range and display	<p>The difference between Accuracy and Resolution is as follows: (1) Actual accuracy, resolution, and repeatability are related to the full operating range from 0 to 2000 ppm; (2) Resolution, also called the <b>Display Resolution</b>, will display 0.01 resolution when less than 20 ppm. (This is due to TSI's ability to program a low-noise sampling system that provides 18-bits of resolution with stable zeroing results. Thus, the display resolution appears as 0.01 compared to other brands which display 0.1.)</p> <p><b>Accuracy:</b> <math>\pm 5\%</math> (<math>\pm 100</math> ppm)  <b>Display Resolution</b> – <math>\pm 2\%</math> repeatability (<math>\pm 40</math> ppm)</p>

### Lamp Questions

2. What lamps will be available? (9.8, 10.6, 11.7 eV)	The EVM PID sensor supports a 10.6eV lamp.
3. Will we offer a moisture trap or hydrophobic filter attachment?	Each gas sensor installed in the EVM, including PID, has a hydrophobic filter contained in the sensor housing.

### Maintenance Questions

4. Is the lamp field replaceable?	The PID lamp can be replaced by the user in the field. A replacement lamp can be ordered from TSI (Part number 074-081). See <a href="#">Chapter 7</a> (Maintenance & Cleaning) for instructions on replacing the PID lamp. <b>NOTE:</b> <i>You need to recalibrate the PID sensor after the lamp is replaced (or cleaned).</i>
5. Can the lamp be cleaned in the field?	The lamp can be cleaned in the field with the PID cleaning kit. A PID cleaning kit is shipped with an EVM unit if ordered with a PID sensor option. A PID cleaning kit can also be ordered from TSI (Part Number 074-080). See <a href="#">Chapter 7</a> (Maintenance & Cleaning) for instructions on cleaning the PID lamp.

Calibration Questions	
6. How do we calibrate the PID?	A PID calibration is a two point calibration consisting of a zero and a span calibration. The flow rate at L/min is recommended for best performance results (i.e., accuracy and repeatability). To perform a zero calibration Pure Air or Nitrogen should be used. To perform a span calibration Isobutylene gas should be used if the specific VOC is unknown or a specific VOC gas can be used. To calibrate the PID sensor navigate to the <b>CALIBRATION/PID</b> screen and perform a zero and span cal by applying gas to the monitor using the supplied calibration cup. See <a href="#">Chapter 4</a> for details on PID calibration.
7. How often is calibration recommended?	TSI recommends calibrating the PID sensor prior to running a log session to adjust for sensor drift and wear.

PID Correction Factors	
8. Do you have a correction factor chart (or a library of PID correction factors) for various VOCs?	TSI has included a correction factor chart with the various VOCs in <a href="#">Appendix C</a> . Please reference as needed.

Cleaning/Maintenance Question	
9. How do I know when to clean/perform maintenance with the PID sensor for VOC measurements?	(1) Replace the electrode pellet if the baseline climbs after performing a zero calibration. (2) Replacement of the electrode is needed under high humid conditions. (3) Cleaning is needed if the baseline is unstable or shifts when you move the PID sensor.

## Power

Question	Response/Solution
1. How long will the battery last with the EVM series?	The battery is an internal lithium-ion rechargeable battery pack which will last at least 8 hours with continuous setup time, run time, and viewing your results time. ( <b>NOTE:</b> The battery is not user accessible or user replaceable.) Battery life-time is estimated at 500 charge cycles or around 3 years of use before you will need to replace the battery pack.

## Alarm Outputs

Question	Response/Solution
1. Is there an alarm output?	The Digital-Out (or digital-output) can be configured for any installed sensor at user specified threshold.



## General: Mechanical

Question	Response/Solution
1. Manifold positioned over sensors: What is the long, black plastic bar over the sensors and how is it used?	The manifold is used to improve response time during the calibration process and use (running, logging, and viewing measurements).
2. What is the Path for Gas (Toxic, CO <sub>2</sub> and PID)	Refer to Figure 1-3 in <a href="#">Chapter 1</a> .

## CO<sub>2</sub> Sensor and how to reorder

Question	Response/Solution
1. How do I order/reorder a CO <sub>2</sub> sensor?	<p>Since the CO<sub>2</sub> sensor vendor changed in June 2012, there are two CO<sub>2</sub> sensor options to order/reorder depending on the model you purchased. See <a href="#">Appendix A</a>, "Accessories: Replacement and Optional Parts" section for specific reorder part information.</p> <p>To determine the appropriate CO<sub>2</sub> sensor part number, do one of the following:</p> <p><b>Method One:</b> Removing the CO<sub>2</sub> sensor from the EVM housing</p> <p><b>Sensors' Locations and Removing</b> (The diagram below is based on the EVM-7 model.)</p> <p><b>NOTE:</b> Verify the unit is off and unplugged from the power cord before removing or inserting sensors.</p> <p>Remove the sensor bar (via the screws) and manifold.</p> <p>Remove the CO<sub>2</sub> sensor by gently lifting the sensor from the housing.</p> <p><b>NOTE:</b> To insert, align the socket pins to the circuit board accordingly.</p> <p><b>Sensor bar</b> – Remove screw 1 &amp; 2 and lift off cover</p>  <p>The diagram shows the top of the EVM-7 sensor housing. A red sensor bar is attached to the top surface. Two screws, labeled 'Screw 1' and 'Screw 2', are used to secure the sensor bar. Below the sensor bar, three sensor ports are visible: 'Toxic sensor', 'PID sensor', and 'CO<sub>2</sub> sensor'. Red arrows point from the labels to the corresponding components in the image.</p>

## CO<sub>2</sub> Sensor and how to reorder (continued)

Determine the type of installed CO<sub>2</sub> sensor by counting the number of pins on the sensor. (See images below.)

7-pin CO<sub>2</sub> sensor (P/N 074-712)  
image:



5-pin CO<sub>2</sub> sensor (P/N 074-733)  
image:

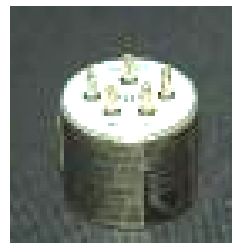

### Method Two:

Using the **Unit Information** screen via the start screen (see A below), press the Enter key until the CO<sub>2</sub> sensor appears on the screen (see B below). A numeric serial code will be displayed to the right column of the CO<sub>2</sub> sensor. Below are the two scenarios to denote the CO<sub>2</sub> sensor type:

- 7 pin sensor (074-712) is displayed by a 5 digit, 6 digit or 8 digit serial number.
- 5 pin sensor (074-733) is displayed by a 10 digit serial number.

A: Start screen on the EVM with Unit Information selected.

**NOTE:** Start screen appears when powered on.

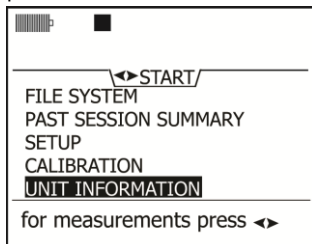

B: Unit Info screen with CO<sub>2</sub> sensor displayed.

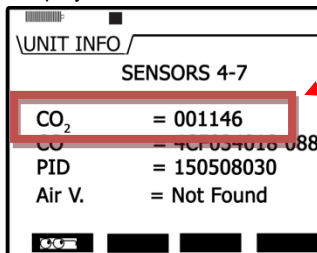

Example of CO<sub>2</sub> serial number is: 00146 which is the 7-pin sensor, P/N 074-712.

## Calibrating Sensors

1. What calibration gases or calibration equipment are needed for calibrating sensors on the EVM series?

Sensor Type	Zero Calibration	Advanced calibration (correction factors)
Particulates sensor	Performed with a zero/HEPA filter (shipped in kit)	Gravimetric filtering (optional) is used to determine a reference point/correction factor relative to the Arizona Road Dust factory calibration.

Sensor Type	Zero Calibration	Advanced calibration (correction factors)
CO <sub>2</sub> sensor	Performed with Nitrogen	CO <sub>2</sub> gas with a 1 Liter/minute flow rate <b>*NOTE:</b> The range of the CO <sub>2</sub> sensor is 0 to 5,000 ppm. It is recommended to span cal to the value you will be measuring (i.e., 4,500 ppm) for best results. Note settling time with 1 L/min gas flow has a response time of <90 seconds.
PID ppm sensor	Performed with Pure Air or Nitrogen <b>*NOTE:</b> Room air can be applied in clean air environments (such as a school with no toxic cleaners present).	Isobutylene is used when the VOCs are unknown. <b>*NOTE:</b> in order to measure a specific VOC, you will use the relevant VOC for your calibrated gas source.
PID ppb sensor	No user cal performed in the field. (Factory cal. only.)	PID sensor ppb – span: 10 ppm (or 10,000 ppb) of Isobutylene whether the gas of interest is known/unknown.
Carbon Monoxide (CO)	Performed with Pure Air or Nitrogen	CO gas
Chlorine (CL <sub>2</sub> )	Performed with Pure Air or Nitrogen	CL <sub>2</sub> gas
Ethylene Oxide (EtO)	Performed with Pure Air or Nitrogen	EtO gas
Hydrogen Cyanide (HCN)	Performed with Pure Air or Nitrogen	HCN gas
Hydrogen Sulfide (H <sub>2</sub> S)	Performed with Pure Air or Nitrogen	H <sub>2</sub> S gas
Nitrogen Dioxide (NO <sub>2</sub> )	Performed with Pure Air or Nitrogen	NO <sub>2</sub> gas
Nitric Oxide (NO)	Performed with Pure Air or Nitrogen	NO gas
Oxygen (O <sub>2</sub> )	Performed with Nitrogen	Room air <b>*NOTE:</b> The range of the O <sub>2</sub> sensor is 0 to 30% with a typical span of 20.9%.
Sulphur Dioxide (SO <sub>2</sub> )	Performed with Pure Air or Nitrogen	SO <sub>2</sub> gas

Sensor Type	Calibration
Pump Flow rate	An accurate flow meter (i.e., bubble-flow meter) and tubing is required to perform this calibration. The tubing and flow meter are connected to the back outlet or in the turret.
Temperature	An accurate temperature sensing instrument (i.e., thermometer) is required to perform this calibration. The instrument is then placed in the location where you will log and the calibration is conducted. <b>*NOTE:</b> when calibrating temperature, ensure the unit is not charging by unplugging the external power cord before proceeding.
Relative Humidity	An accurate temperature sensing instrument (i.e., psychrometer) is required to perform this calibration. The instrument is then placed in the location where you will log and the calibration is conducted. <b>*NOTE:</b> when calibrating relative humidity, ensure the unit is not charging by unplugging the external power cord before proceeding.

**\*\*NOTE:** before performing a user calibration, ensure that your calibration is performed in an area known not to contain hazardous or interfering gases if ambient air will be used as the zero gas for operation. If this is not possible, pure bottled air (Nitrogen is recommended) should be substituted.

**About Zero Calibration:** A Zero calibration is advised each time you log a session to adjust for drift in the sensor's sensitivity which occurs over time and after use.

**About Span Calibration:** A span calibration proceeds a zero calibration and is used to set the linear measuring range. The span should be a sizeable fraction of the selected full scale range of the gas.

# Appendix E

## System Errors Displayed on the EVM Series

There are two types of pop-up notifications that may appear on your instrument.

**Monitor system errors** – The EVM is equipped with numeric system errors which range from 101 to 108. If a numeric system error appears, please call TSI for [Technical Support and Service](#). Noting the System Error code is very useful for the call.

**Monitor errors** – Pop-up screens may appear as you are using the instrument. These are to notify you of various errors/cautions statements. All of the errors are listed below with an explanation. Press **Enter** and adhere to the monitor warning screens. If you have any questions, please call TSI for Technical Support.

Monitor Errors	Explanation
<b>Battery charger disabled at current temperature</b>	The battery is either too hot or too cold to charge.
<b>Battery charging failure</b>	If this appears frequently, this indicates the instrument may need to be serviced. Contact TSI's <a href="#">Technical Support</a> for help.
<b>Battery low</b>	The battery is almost depleted and powering off of external power. <b>NOTE:</b> Turn the monitor off or plug in the power cord.
<b>Right error: Duplicate profile name</b>	The dust profile names that the user can set must be unique or this error will appear. (See <a href="#">Chapter 3</a> for details.)
<b>Analog-out channel sensor invalid</b>	If analog-out is enabled and a sensor is selected (such as CO) and you remove that sensor, this monitor warning will appear. (Re-insert the sensor if desired.) <b>NOTE:</b> The Digital-out field will automatically disable and select the next available detectable sensor.
<b>Invalid impactor setting to start logging</b>	When the impactor reads at an incorrect setting, it will not allow you to log without turning the turret to a correct setting.
<b>Laser not functioning properly</b>	Either the laser is unplugged or needs to be serviced. Make sure the laser is connected (This is the multi-colored cable which attaches from the laser to the connectors located by the gravimetric cassettes.)
<b>Logging stopped due to impactor change</b>	The instrument does not allow you to change the impactor setting during run mode. To correct this, stop logging. Change the impactor and then continue with Running/logging measurements.

Monitor Errors	Explanation
<b>File system full. Delete files to continue</b>	Files will need to be deleted before proceeding with logged measurements. (See File System menu for more information.)
<b>File system error. Logging failed</b>	Message will appear when there is not enough memory to store new files. You will want to delete files in order to proceed. (See File System menu for more details.)
<b>PID sensor error</b>	This indicates one of the following: (1) Clean the sensor, (2) The lamp needs replacing, (3) replace the electrode pellet, (4) or replace the sensor
<b>Pump unable to regulate</b>	The pump tries to maintain 1.67 L/min flow rate. When the flow rate is not maintained, this message will appear.  <b>Reason:</b> The gravimetric cassette may need to be replaced or detach any external devices (such as a cyclone). Or it will need to be serviced.
<b>Set time and date – clock has been reset</b>	This will appear if the battery was depleted. You will want to reset the time and date.  <b>NOTE:</b> The time and date field are used for calibration and logged files.
<b>Digital-out channel sensor invalid</b>	If digital-out is enabled and a sensor is selected (such as PM) and you remove that sensor, this monitor warning will appear. (Re-insert the sensor if desired.)  <b>NOTE:</b> The Digital-out field will automatically disable and select the next available detectable sensor.
<b>Sensor not found xxx (i.e., CO)</b>	A warning message will appear when a sensor (gas, toxic, PID, RH/Temp, or dust) is removed.  <b>NOTE:</b> The instrument needs to be turned off when sensors are removed. This is to notify you that a sensor has been removed or changed.
<b>Sensor found xxx (i.e, CO)</b>	Likewise, a monitor warning message will appear when a sensor is removed and replaced back in. This is helpful if you are changing different toxic sensors.
<b>PM disabled</b>	If the user disabled particulates via the particulates setup screen. Then the pump key will not function.

## INDEX

% .....	74	Digital output .....	18
Air Velocity Accessory		Digital Output	
Specifications .....	121	using stereo plug and diagram .....	156
Analog out .....	33	Display settings explained .....	22
Analog output .....	18	Dummy Sensor	
Backlight key .....	36	Defined .....	136
Batteries		Estimated Run Time	
indicator .....	14	Screen .....	89
Battery .....	17	Ethylene Oxide	
Bubble flow meter		Measuring range .....	54
Connecting .....	53	EVM keypad and display explained .....	12
Calibrating		EVM kit .....	11
Gravimetric cal overview .....	51	FAQ's	
Reset gravimetric setting .....	52	Alarm outputs (See Analog Input/Output) .....	158
Connecting gas sensor .....	56	Analog or digital out connection .....	156
Drifting analysis .....	68	Battery power .....	158
Flow Rate Calibration .....	54	Can we adjust the flow rate? .....	155
Inert tubing .....	56	Can we run the unit without a cassette .....	153
Ozone zero and span cals .....	57	Does Quest offer cassettes .....	153
Particulates zero cal .....	47	Gravimetric cassette sizes .....	153
Performing a gravimetric .....	52	How can we verify the constant flow? .....	155
Photo-Ionization Detector (PID) Sensor .....	63	How do we calibrate the pump .....	155
PID PPB span cal .....	64	How is the flow rate controlled .....	155
PID PPM span cal .....	64	how is theParticulates	
PID PPM zero cal .....	63	EVM-7 and EVM-3 calibrated in the factory .....	152
Pump flow rate calibration .....	53	How many toxics can I measure simultaneously .....	154
Relative Humidity or Temperature calibration .....	66	How often to calibrate the pump? .....	155
Saved Calibration screen .....	60	life expectancy and warranty on the various Sensors .....	154
Selecting a calibration sensor screen .....	61	Maintenance and Lamp questions .....	157
Setting CO2 Span Cal screen .....	62	Measuring range and display .....	157, 158, 159
span cal for Toxic gas .....	59	Mechanical	
Toxic Gas overview .....	56	What is the long, black plastic bar over the sensors and	
Verify calibration .....	68	how is it used? .....	159
Zero cal and span cal for CO2 or for O2 sensor .....	60	Particulates	
Zero cal for toxic gas .....	57	Adding Correction factor after running/logging	
Zero Cal set for Particulates .....	51	particulate measurements .....	152
Calibrating particulates		Calibrate before I run real-time particulate	
Arizona Road Dust .....	44	measurements .....	152
Calibration		Calibrate particulates in accordance to NIOSH0600 .....	152
Example of Cal history chart in QSP-II .....	55	Clean the optical engine/photometer .....	152
Carbon Monoxide		Correction factors .....	152
Measuring range .....	54	Cut-points .....	151
Charging .....	18	How often do you need to apply the grease to the	
Check battery power .....	21	impactors .....	151
Chlorine		Impactor cut-points .....	151
Measuring range .....	54	Impactor function when there is a build-up of	
Communicating with QSP-II via USB cable .....	17	particulates (in a conical shaped pyramid) .....	151
Composite measurement screen .....	80	Inhalable or respirable gravimetric sample .....	151
Composite with details screen .....	82	Verify the calibration .....	152
Confined Space		Replacing filters (which are supplied in the kit) .....	153
Defined .....	135	What calibration gases or calibration equipment are	
Cyclone		needed for calibrating sensors on the EVM? .....	160
Using .....	76	Will the pump always regulate .....	155
Delete session message .....	87	File system menu .....	86
Deleting all sessions .....	87	File Systems properties screen .....	88
Deleting sessions .....	86	Filtered CO sensor vs. Unfiltered	
Digital out/Logic settings .....	31	Defined .....	136

Fire Triangle	
Defined .....	136
ft/m .....	74
Gas calibration softkeys	
Explained .....	58
Gas measurement screen .....	79
Gases	
cross sensitivity .....	55
Gravimetric analysis	
Defined .....	136
Gravimetric cassette and filter paper .....	117
Replacing .....	117
Hydrogen Cyanide	
Measuring range .....	54
Hydrogen Sulfide	
Measuring range .....	54
Identifying your equipment .....	11
IDLH	
Defined .....	137
Impactor	
Adjusting impactor/turret setting .....	47
Greasing and cleaning .....	45
How it operates .....	45
Use .....	46
Impactors	
Cut-points .....	46
Indicators (i.e., run, stop, battery, Altf) .....	14
Keypad/user interface explained .....	13
Level	
Defined .....	138
Lock/secure	
Run and Setup screen .....	37
Lock/Security	
Lock Softkey .....	37
Run mode steps .....	36
Setup steps .....	36
Lookup icon (eyeglasses) softke .....	75
m/s .....	74
m <sup>3</sup> .....	74
Magnifying glass symbol .....	75
Measurement values	
AVG .....	78
Level .....	78
MAX .....	78
Min .....	78
STEL .....	78
TWA .....	78
Measurements	
Zoomed in .....	80
Zoomed out .....	80
Measurements units	
Specifications .....	122
Measuring	
Changing views .....	77
Logged data .....	72
Quick help list .....	71
Sample summary data in QSP-II .....	72
Stored data .....	72
Summary data .....	72
Time History data .....	72
Memory	
Estimated logged run time .....	89
Memory remaining and file properties .....	88
mg .....	74
mg/m <sup>3</sup> .....	74
MSHA	
Defined .....	140
Navigating .....	14
Navigating screens .....	74
Nitric Oxide	
Measuring range .....	54
Nitrogen Dioxide	
Measuring range .....	54
°C .....	74
°F .....	74
OL .....	74
Optical engine and cleaning .....	114
Overload .....	14
Oxygen	
Measuring range .....	54
packing instructions .....	132
Particulates	
User profiles .....	45
Particulates correction factors	
Setting .....	28
Particulate matter	
Defined .....	138
Particulate Measurement screen .....	76
Particulate Sensor	
Specifications .....	119
Parts	
Listing .....	128
Past session	
Summary screen .....	86
Past session screen .....	84
Peak	
Defined .....	139
PEL	
Defined .....	139
PID sensor	
Correction factor setup screen .....	26
PID sensor & correction factors table .....	141
PM measurements	
Extending run-time .....	76
Power	
Turn on .....	13
ppb .....	74
ppm .....	74
Relative Humidity	
Defined .....	140
Relative Humidity Sensor	
Specifications .....	120
Relative Sensitivity	
Defined .....	140
Resetting the EVM .....	36
Restoring Default factory settings .....	34
returning for service .....	132
RH and temperature measurement screen .....	78



run a noise study .....	84	Start screen defined .....	13
Run mode .....	14	STEL	
Run Time		Defined .....	138
Explained .....	23	Stereo plug	
Running .....	73	How to connect .....	156
running a study		Stop mode .....	14
steps .....	71	Stopping .....	73
Select softkey .....	75	Sulphur Dioxide	
Sensors		Measuring range .....	54
Cleaning of the PID .....	111	Time-Date screen .....	20
ID sensor with lamp and electrode pellet removed/inserted .....	112	TLV	
Inserting and removing .....	43	Defined .....	140
PID - Removing intelligent-sensor casing .....	111	Toxic Gas Sensors	
PID - Removing the lamp with removal tool .....	112	Specifications .....	121
PID maintenance/cleaning benchmarks .....	111	Trend data screen	
PID sensor cleaning kit .....	112	About .....	83
Removing and inserting PID .....	110	Trend Screen .....	84
Sensor housing and manifold .....	43	Trend softkey .....	75
Serial numbers .....	55	Turning off .....	15
Sensors' locations		TWA	
Diagram .....	44	Defined .....	138
Setting or changing digital output .....	31	Unit Information screen .....	15
Settings		Unlock	
Correction factor .....	28	Quest default code .....	38
Edit profiles for dust calibration .....	29	Unlock/Security	
Gravimetric Mass and Gravimetric volume fields .....	27	Run mode .....	38
Particulate field .....	27	Setup .....	38
Particulates .....	27	UR .....	74
Profile field .....	27	Viewing installed sensors .....	16
Pump: enable or disable .....	30	VOC	
Resetting the Gravimetric .....	30	Defined .....	140
Temperature and air velocity .....	27	Volatile Organic Compounds	
Time and Date .....	19	Specifications .....	119
Start screen .....	21	µg/m <sup>3</sup> .....	74



TSI Incorporated – Visit our website [www.tsi.com](http://www.tsi.com) for more information.

**USA** Tel: +1 800 874 2811  
**UK** Tel: +44 149 4 459200  
**France** Tel: +33 1 41 19 21 99  
**Germany** Tel: +49 241 523030

**India** Tel: +91 80 67877200  
**China** Tel: +86 10 8219 7688  
**Singapore** Tel: +65 6595 6388



 **SIAFA**<sup>®</sup>  
Higiene Ocupacional y Medio Ambiente

 [www.siafa.com.ar](http://www.siafa.com.ar)  
 [ventas@siafa.com.ar](mailto:ventas@siafa.com.ar)

 **011 4684 2232**