



Gas and Flame Detection



# Operation and Maintenance Manual

---

GASMAX EC Loop-Powered Toxic Gas Monitor

---



GDS Corp.  
2513 Hwy 646 • Santa Fe, Texas 77510  
409-927-2980 • 409-927-4180 (Fax) • [www.gdscorp.com](http://www.gdscorp.com)

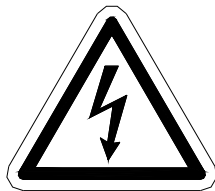

**CAUTION: FOR SAFETY REASONS THIS EQUIPMENT MUST BE OPERATED AND SERVICED BY QUALIFIED PERSONNEL ONLY. READ AND UNDERSTAND INSTRUCTION MANUAL COMPLETELY BEFORE OPERATING OR SERVICING.**

**ATTENTION: POUR DES RAISONS DE SÉCURITÉ, CET ÉQUIPEMENT DOIT ÊTRE UTILISÉ, ENTRETENU ET RÉPARÉ UNIQUEMENT PAR UN PERSONNEL QUALIFIÉ. ÉTUDIER LE MANUE D'INSTRUCTIONS EN ENTIER AVANT D'UTILISER, D'ENTRETENIR OU DE RÉPARER L'ÉQUIPEMENT.**

REVISION HISTORY

Revision 3.5.1 4/15/13 Initial rewrite for GASMAX EC

## CONTENTS

<b>1</b>	<b>SAFETY INFORMATION</b>	<b>8</b>
<b>2</b>	<b>GENERAL INFORMATION</b>	<b>9</b>
	Introduction	9
	GASMAX Sensors	9
<b>3</b>	<b>SPECIFICATIONS</b>	<b>10</b>
<b>4</b>	<b>INSTALLATION</b>	<b>11</b>
	Locating the GASMAX EC	11
	Mounting the GASMAX Instrument Enclosure	11
	Mounting the GASMAX Remote Sensor Enclosure	12
	Explosion Proof Installation	12
	Intrinsically Safe Installation	13
	Connecting Loop Power / Signal Wiring	13
	Local Smart Sensor	14
	Connecting a Remote Sensor	15
	Initial Setup	16
<b>5</b>	<b>CALIBRATION</b>	<b>18</b>
	Calibration Overview	18
	Calibration Procedure	19
<b>6</b>	<b>OPERATION AND MAINTENANCE</b>	<b>21</b>
	GASMAX Display Screens	21
	Data Display Screen	21
	Trend Display Screen	22
	Normal Operation	22

<b>Alarm Operation – ALARM 1 and 2</b>	<b>22</b>
<b>Alarm Operation – ALARM 3</b>	<b>23</b>
<b>Sensor Replacement</b>	<b>23</b>
<b>Sensor Replacement – Remote Sensors</b>	<b>25</b>
<b>Normal Maintenance</b>	<b>25</b>
<b>7 USER MENUS</b>	<b>26</b>
<b>Main Menu</b>	<b>26</b>
<b>System Configuration Page</b>	<b>27</b>
Measurement Name	27
Eunits	27
Zero (0%)	27
Span (100%)	27
Decimal Points	27
Cal Span Value	27
Readout Deadband	27
Track Negative	27
Temp Compensation	28
Backup Config	28
Restore Config	28
Upload Sensor Data	28
Cal Marker	28
TX Sensor Life	28
<b>Alarm Settings Page</b>	<b>29</b>
Set Point	29
Dead-Band	29
ON Delay	29
OFF Delay	29
Low Trip	29
Latching	29
Display Event Log	30
Clear Event Log	30

<b>Sensor settings page</b>	<b>30</b>
Install New Sensor	30
Recall Cal History	30
Input Type	30
New Sensor	30
Recent Cal	30
<b>CLOCK/DELAY SETUP Page</b>	<b>31</b>
Time	31
Date	31
Warm Up Delay	31
Cal Purge Delay	31
<b>LCD CONTRAST Adjustment Page</b>	<b>31</b>
<b>HELP Screen Page</b>	<b>31</b>
<b>DIAGNOSTICS Page</b>	<b>31</b>
Output Simulation	32
Relay Test	32
<b>SYSTEM SECURITY Page</b>	<b>32</b>
Contact Name	32
Secure Level	32
<b>8 TECHNICIANS MENUS</b>	<b>33</b>
<b>XMITTER CONFIG Menu</b>	<b>33</b>
O2 / Toxic	33
LEL / Current	33
Output Zero / Span Trim	33
Real Time Clock	33
Model	33
<b>TECHNICAL PAGE Menu</b>	<b>34</b>
Set Balance	34
Set Voltage	34
Preamp Gain Set	35
Input Type	35
Zero Cal Value	36

Raw Min / Max Counts _____	36
Marker Menu _____	36
<b>9 TROUBLESHOOTING GUIDE _____</b>	<b>37</b>
<b>Toxic Sensor Indicates Fault or Overrange _____</b>	<b>37</b>
<b>Toxic Sensor Will Not Calibrate _____</b>	<b>37</b>
<b>Receiving Device and GASMAX Displayed Values Don't Match _____</b>	<b>37</b>
<b>GASMAX Display Blank _____</b>	<b>37</b>
<b>GASMAX Error Codes _____</b>	<b>37</b>
<b>10 SPARE PARTS _____</b>	<b>39</b>
<b>Display &amp; Enclosure _____</b>	<b>39</b>
<b>Sensor Head Accessories _____</b>	<b>39</b>
<b>Remote Sensor _____</b>	<b>40</b>
<b>11 DRAWINGS AND DIMENSIONS _____</b>	<b>41</b>

**TABLE OF FIGURES**

FIGURE 3-1: GASMAX EC TOXIC SENSORS ..... 10

FIGURE 4-1: GASMAX EC EXPLOSION PROOF ENCLOSURE ..... 11

FIGURE 4-2: GASMAX EC REMOTE SENSOR ..... 12

FIGURE 4-3: GASMAX EC LOOP POWER WIRING ..... 13

FIGURE 4-4: LOCAL SMART TOXIC SENSOR ..... 14

FIGURE 4-5: GASMAX EC REMOTE SENSOR WIRING ..... 15

FIGURE 4-6: GASMAX INTRINSICALLY SAFE INSTALLATION ..... 16

FIGURE 4-7: GASMAX EC IS WIRING GUIDELINES ..... 16

FIGURE 5-1: CALIBRATION SETUP ..... 19

FIGURE 5-2: CALIBRATION FLOWCHART ..... 20

FIGURE 6-1: GASMAX EC DISPLAY SCREENS ..... 21

FIGURE 6-2: GASMAX DATA DISPLAY SCREEN ..... 22

FIGURE 6-3: GASMAX TREND DISPLAY SCREEN ..... 22

FIGURE 6-4: SENSOR REPLACEMENT ..... 24

FIGURE 6-5: SMART SENSOR RECOGNITION SCREEN ..... 24

FIGURE 7-1: MAIN MENU FLOWCHART ..... 26

FIGURE 7-2: SYSTEM CONFIG MENU ..... 27

FIGURE 7-3: SENSOR LIFE TRANSMISSION FORMAT ..... 28

FIGURE 7-4: ALARM SETTINGS MENU ..... 29

FIGURE 7-5: SENSOR SETTINGS MENU ..... 30

FIGURE 7-6: CLOCK DELAY MENU ..... 31

FIGURE 7-7: CONTRAST MENU ..... 31

FIGURE 7-8: DIAGNOSTICS MENU ..... 32

FIGURE 7-9: SYSTEM SECURITY MENU ..... 32

FIGURE 8-1: XMITTER CONFIG MENU ..... 33

FIGURE 8-2: TECHNICAL PAGE MENU ..... 34

FIGURE 8-3: SET GAIN TO UNITY MENU ..... 35

FIGURE 8-4: PREAMP GAIN SET MENU ..... 35

FIGURE 10-1: GASMAX EC + LOCAL SENSOR SPARE PARTS ..... 39

FIGURE 10-2: GASMAX SENSOR HEAD SPLASH GUARD & FLOW CELL ..... 39

FIGURE 10-3: GASMAX EC REMOTE DIRECT SENSOR HEAD ..... 40

## 1 SAFETY INFORMATION

### Important – Read Before Installation

Users should have a detailed understanding of GASMAX EC operating and maintenance instructions. Use the GASMAX EC only as specified in this manual or detection of gases and the resulting protection provided may be impaired. Read the following WARNINGS prior to use.

#### WARNINGS

- The GASMAX EC gas monitor described in this manual must be installed, operated and maintained in accordance with information contained herein. Installation in any hazardous area must comply with all applicable restrictions, requirements and guidelines for said hazardous areas. It is the end user customer's final decision to ensure that the GASMAX EC is suitable for the intended use.
- The GASMAX EC is designed and constructed to measure the level of certain gases in ambient air. Accuracy in atmospheres containing steam or inert gases cannot be guaranteed.
- Always mount the sensor head vertically with the sensor head facing down.
- Do not paint transmitter or sensor assembly.
- Do not operate the GASMAX EC if its enclosure is damaged or cracked or has missing components. Make sure the cover, internal PCB's and field wiring are securely in place before applying power.
- Do not expose the GASMAX EC to electrical shock or continuous severe mechanical shock. Protect the GASMAX EC and related sensor assemblies from dripping liquids and high power sprays.
- Calibrate with known target gas at start-up and check on a regular schedule, at least every 90 days. More frequent inspections are encouraged to spot problems such as dirt, oil, paint, grease or other foreign materials on the sensor head.
- Periodically test for correct operation of the system's alarm events by exposing the monitor to a targeted gas concentration above the High Alarm set point.
- Use only for applications described within this manual.



## 2 GENERAL INFORMATION

### Introduction

The GASMAX EC is a single channel fixed-point gas monitor designed to provide continuous monitoring of toxic or combustible gases in hazardous areas. Gas values are displayed in calibrated engineering units as well as bar graph or 30-minute trend graph format.

The GASMAX EC supports one local or remote mount sensors for toxic gas. The advanced microcontroller, non-intrusive magnetic interface and superior graphic LCD interface offers rapid setup, simplified operation and enhanced diagnostics not found in previous generation products. On-board non-volatile memory retains all configuration data during power interruptions. A single loop-powered 4-20 mA output allow for easy connection to control systems or other alarm instrumentation.

Built-in user-prompted calibration makes it easy for one person to perform calibration and maintenance without opening the enclosure or declassifying the area. A battery-powered real-time clock and event log allows the GASMAX EC to track calibration and alarm events for later recall on the LCD readout.

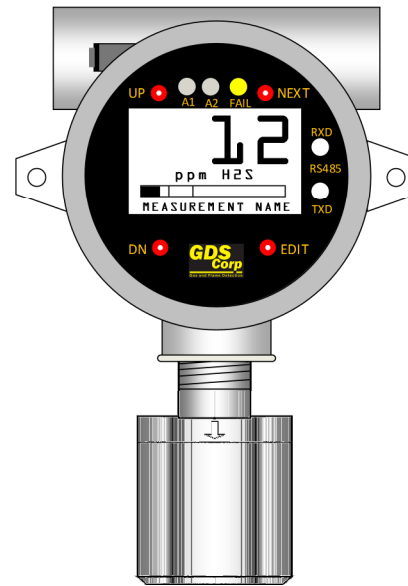

### GASMAX Sensors

For toxic gases the GASMAX EC supports a wide range of electrochemical (“echem”) sensors. These sensors use chemical reactions to sense the presence of gases such as hydrogen sulfide, chlorine, sulfur dioxide and many others. Echem sensors output very low level signals; remote echem sensors should be mounted no more than 15 feet from the GASMAX enclosure, the wiring should be three-conductor with foil shield, and the wiring should be enclosed in metal conduit for maximum protection against interference. If longer distance is required, the GASMAX offers a sensor-transmitter option for electrochemical sensors that converts the output into a 4-20mA signal. Distances up to 500 feet are practical with 4-20mA signals. Channel 1 on the GASMAX EC can be configured for direct echem or 4-20mA input.

**IMPORTANT: TOXIC SENSORS ARE SUBJECT TO ACCELERATED DETERIORATION IF POWER IS NOT SUPPLIED WITHIN 3 MONTHS OF SHIPMENT FROM GDS CORP.**

### 3 SPECIFICATIONS

Power Input	10-30VDC at less than 0.75W
Display	64 x128 pixel LCD with engineering units, bargraph and 30-minute trend
Input	Accepts microamp-level inputs from local or remote GDS Corp toxic or oxygen deficiency sensors
Accuracy	+/- 5% of full scale (typical)
Standard Output	Two-wire 4-20mA loop powered current sink with fault and overrange indication. Maximum loop resistance is 600 ohms with standard 24VDC supply
Temperature	Electronics -40°C to +60°C. See Echem Sensor Manual for additional details
Memory	On-board non-volatile memory retains all user settings
Housing	Aluminum housing with epoxy paint standard; #316 stainless steel optional
Dimensions	Width 5.4" (137 mm), Height 8" (203 mm), Depth 5" (127 mm) Shipping weight 6.5 pounds (3 kg)
Approvals	CSA Certified Division 1 & 2 Groups B, C, D. Suitable for explosion-proof installations with flame arrestor. CSA Certified Division 1 & 2 Groups A, B, C, D. Intrinsically safe when used with IS barrier #10-0263 (MTL 7787P+) or equivalent. ATEX Certified EX II 2 G EEx d IIB + H2 T5
Warranty	Two years on electronics, one year on sensor

10	Oxygen	22	Ethylene Oxide
11	Carbon Monoxide	23	Arsine
12	Chlorine	24	Silane
13	Chlorine Dioxide	25	Fluorine
14	Hydrogen	26	Phosgene
15	Hydrogen Sulfide	27	Hydrazine
16	Hydrogen Cyanide	28	Nitric Oxide
17	Hydrogen Chloride	29	Nitrogen Dioxide
18	Hydrogen Fluoride	30	Mercaptan
19	Sulfur Dioxide	31	Tetrahydrothiophene
20	Ammonia	32	Diborane
21	Ozone	33	Hydrogen Sulfide (Low RH)

**Figure 3-1: GASMAX EC Toxic Sensors**

## 4 INSTALLATION

### Locating the GASMAX EC

Factors such as air movement, gas density in relation to air, emission sources and environmental variables affect correct sensor location. Air movement by fans, prevailing winds and convection should be carefully evaluated to determine if a leak is more likely to raise gas levels in certain areas within the facility. Vapor density of a gas determines if it will rise or fall in air when there are no significant currents. Lighter than air gases should have the monitors mounted 12 – 18 inches (30 – 45 cm) above the potential gas leak and heavier than air gases should be this distance below. Even though the GASMAX EC is designed for rugged service, sensors should be protected from environmental damage from water, snow, shock, vibration and dirt.

### Mounting the GASMAX Instrument Enclosure

The GASMAX EC standard enclosure is a cast aluminum explosion-proof (NEMA 7) enclosure as shown in Figure 4-1.

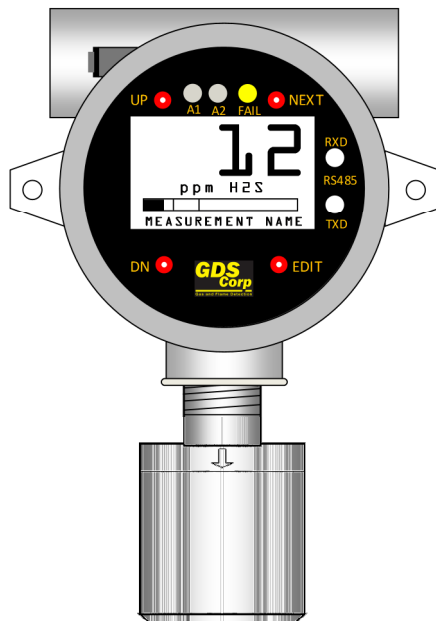

**Figure 4-1: GASMAX EC Explosion Proof Enclosure**

The GASMAX EC should always be mounted with the sensor head opening facing down. If necessary, a Splash Guard (p/n 10-0205) should be attached if there is any chance that water or liquid spray could enter the sensor opening from below. Be sure to leave sufficient room (~ 12") below the sensor head to allow easy access for attachment of a Calibration Cup and / or removal of the sensor head cover for sensor replacement.

### Mounting the GASMAX Remote Sensor Enclosure

The GASMAX EC remote sensor consists of a cast aluminum explosion-proof junction box and stainless steel sensor head (see Fig. 4-2). The junction box contains a PCB with connection point for the sensor head cable and wiring terminals for the three-wire connection to the GASMAX EC display enclosure. Fittings are 3/4" NPT. The sensor head should ALWAYS be mounted vertically as shown, and GDS Corp recommends side entry for all conduit runs.

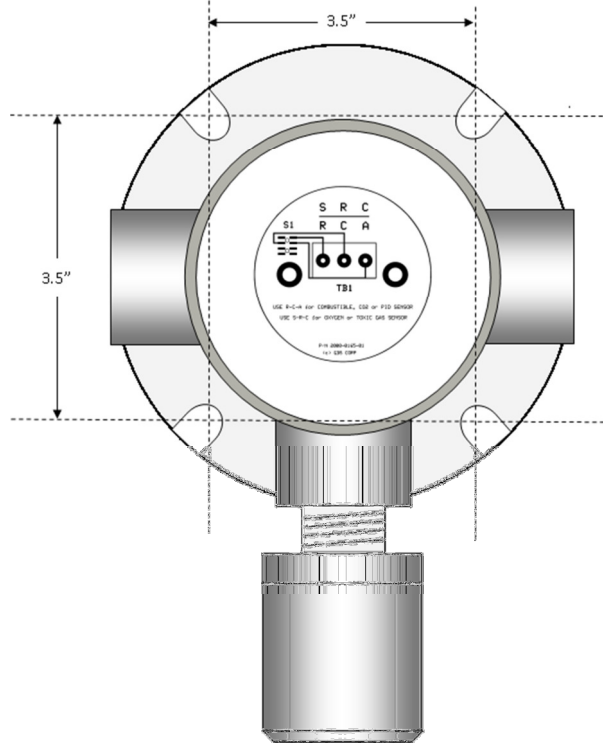

Figure 4-2: GASMAX EC Remote Sensor

### Explosion Proof Installation

GASMAX EC monitors with standard explosion-proof sensor heads are certified for use in Class 1 Division 1 hazardous areas. Installation in these areas should follow best industry standard practices and all appropriate electrical codes. Generally, these codes require rigid metal conduit, poured seals and other installation elements necessary to ensure safety. In all cases, GDS Corp recommends the GASMAX EC be mounted vertically with the sensor opening facing down. If there is a possibility that water or other liquid may be present, GDS Corp further recommends the installation of a Splash Guard (p/n 10-0205) to protect the sensor from damage. For maximum protection against interference or electrical surge, the GASMAX EC enclosure and conduit must be properly grounded.

### Intrinsically Safe Installation

GASMAX EC monitors with standard explosion-proof sensor heads, or with sensor heads designed for reactive gases may be installed as “Intrinsically Safe”. Wiring for IS devices is simpler to install and generally does not require conduit; however, in any case, adequate protection against chafing, crushing or other hazards should be considered, and an appropriate IS barrier must be installed where the wiring enters a safe area (see Installation Drawing #GDS-11-0100-EC, Fig. 4-6). For maximum protection against interference or electrical surge, the GASMAX EC enclosure and any conduit must be properly grounded. Shielded wire is recommended for all low power signal runs.

### Connecting Loop Power / Signal Wiring

To access the GASMAX signal / power connections, remove the cover on the GASMAX EC explosion-proof enclosure. Loosen the 2 thumbscrews holding the display assembly in place and remove it. Route the power / signal wires through the conduit entry and connect to green terminal block “TB1” (see Fig. 4-3). Positive and negative wires are interchangeable. The maximum distance 4-20 mA signals can travel is dependent upon several factors including the cable gauge, DC power supply voltage level and impedance of the input of the receiving device. Assuming a nominal 24 VDC power supply, maximum total loop resistance is approximately 650 ohms.

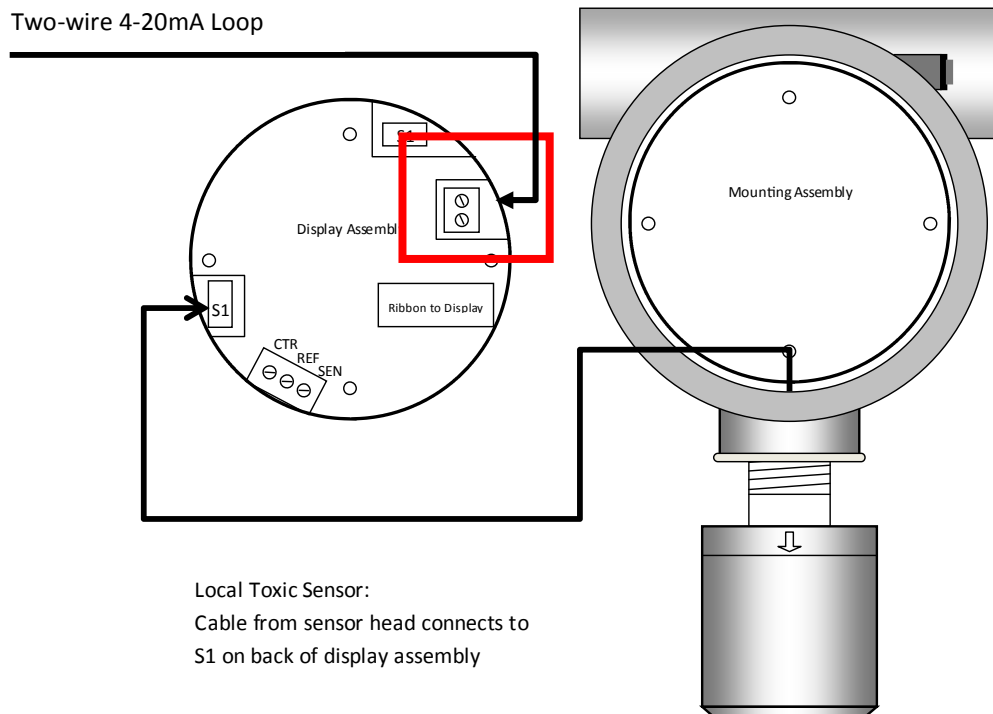

**Figure 4-3: GASMAX EC Loop Power Wiring**

### Local Smart Sensor

Local toxic sensors are factory installed in a sensor head directly attached to the GASMAX EC enclosure. Local toxic sensors are always connected to the Smart Sensor connector "S1" located on the **back of the Display Assembly** (See Fig.4-4).

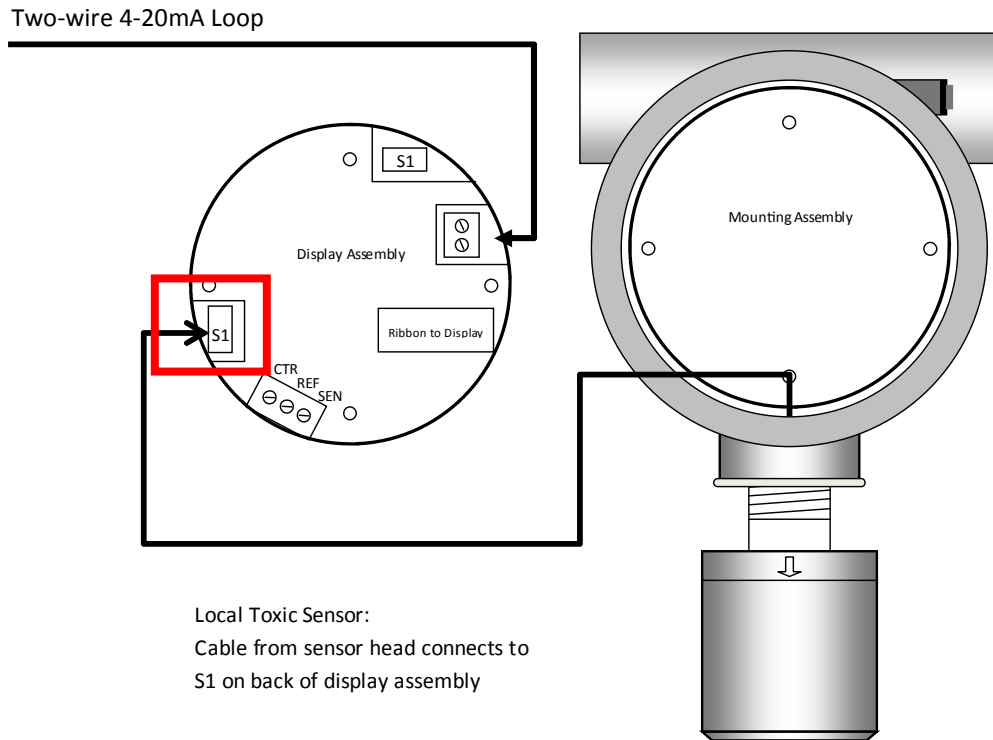

Figure 4-4: Local Smart Toxic Sensor

**IMPORTANT:** TOXIC SENSORS ARE SUBJECT TO ACCELERATED DETERIORATION IF POWER IS NOT SUPPLIED WITHIN 3 MONTHS OF SHIPMENT FROM GDS CORP.

### Connecting a Remote Sensor

GASMAX EC monitors with remote-mount toxic sensors are shipped in two pieces and sensor wiring must be installed by the end user. Remote toxic sensors connect to the Channel 1 Simple Sensor input on the back of the Display Assembly as shown in Figure 4-6.

Due to the small signal output from toxic sensors, remote direct input toxic sensors should be mounted no more than 15 wire-feet from the GASMAX EC display. Further, the cable used should be three-wire stranded with foil shield and should be run inside metallic rigid conduit. GDS Corp recommends Belden B8771. The cable shield must be connected to an earth ground at ONE END ONLY.

Two-wire 4-20mA Loop

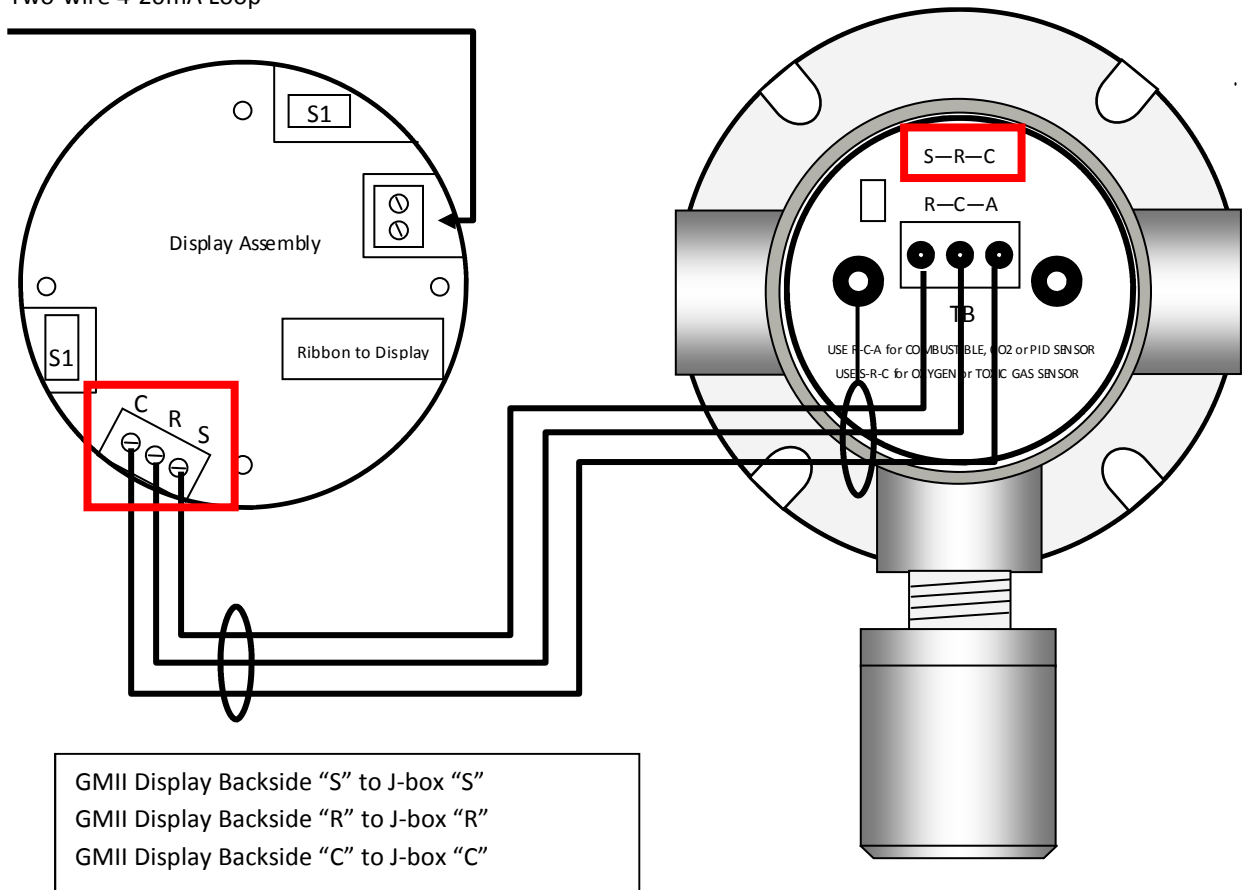

Figure 4-5: GASMAX EC Remote Sensor Wiring

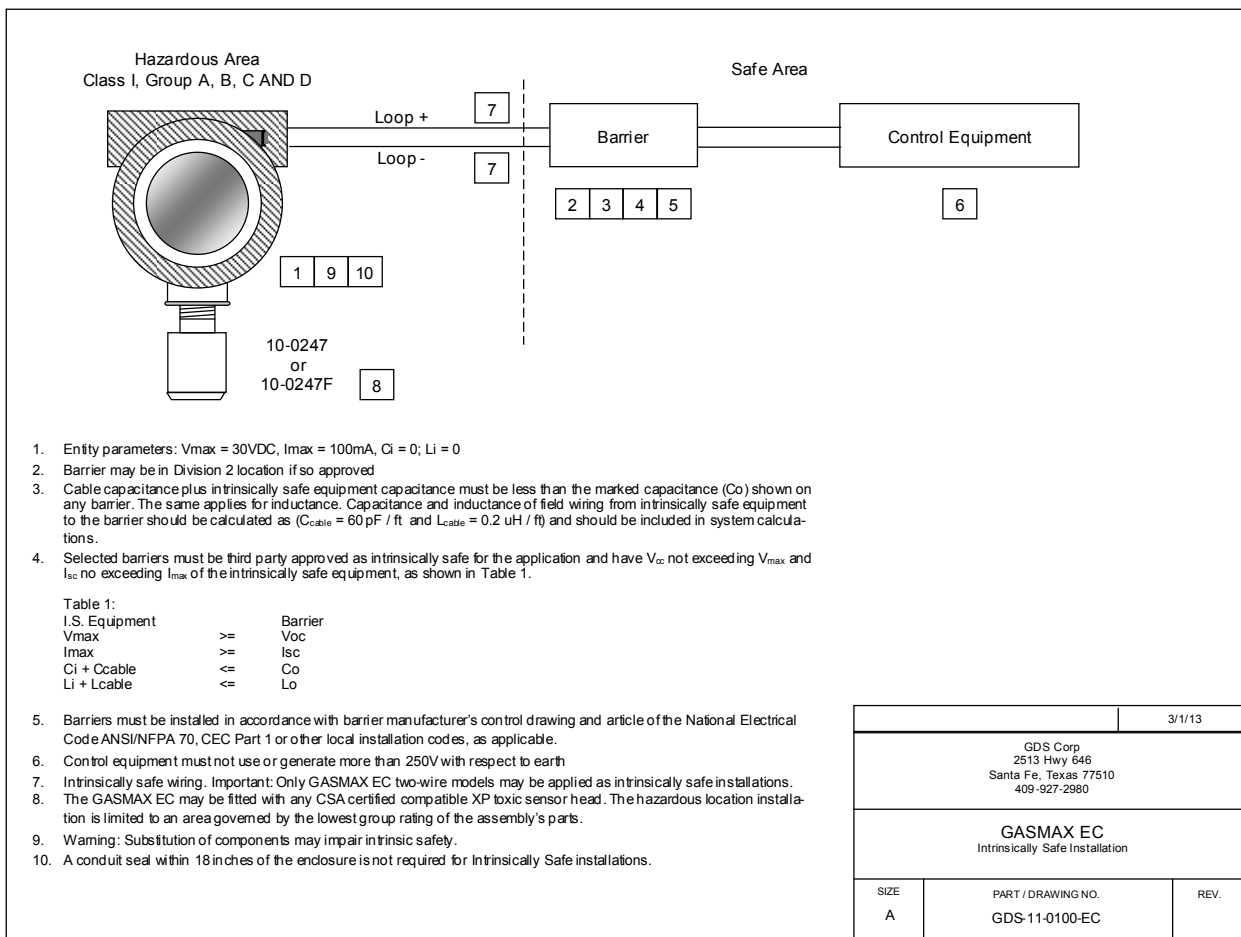

Figure 4-6: GASMAX Intrinsically Safe Installation

### Initial Setup

Once installed, apply power to the GASMAX EC and verify that the LCD display is active. Certain sensors may initially indicate off-scale high or low values, but should quickly return to zero if no target gas is present. During this warm-up delay period, the 4-20mA output is held at 4.0 mA to eliminate false alarms in any receiving devices. Warm-up delay is one of the user-adjustable parameters (see Section 6).

Once operational, the user should verify the following settings prior to initial calibration:

1. Local time and date: Check date value and adjust time for proper time zone (Sec. 6-5).
2. Tag name or Engineering Units settings: Edit values as necessary (Sec 6-2).
3. CAL SPAN GAS value: Set to match concentration of calibration gas cylinder (Sec 6-2).



4. CAL MARKER value: Adjust desired output mA during calibration (Sec 6-2).
5. ALARM 1, ALARM 2 settings: Set for desired levels. NOTE: GASMAX EC programmable alarm levels affect operation of front panel LEDs only (Sec 6-3).

Allow the GASMAX EC to stabilize for at least four hours, preferably overnight if possible. This will allow the sensor to reach stable equilibrium with respect to environmental conditions such as ambient temperature, humidity, and barometric pressure as well as applied “reference” and “counter” voltages generated by the GASMAX EC electronics. At this point, the GASMAX EC can be calibrated and made operational.

## 5 CALIBRATION

### Calibration Overview

Calibration is critically important to ensure correct operation of the GASMAX EC. The built-in CAL MODE function is designed to make calibration quick, easy and error free; a successful ZERO and SPAN calibration requires only four keystrokes. During CAL MODE zero and span, the sensor output is disconnected and the GASMAX EC transmits a fixed mA value, called the CAL MARKER, to notify the receiving device that a calibration is in progress. During the following CAL PURGE DELAY time, the GASMAX EC transmits a fixed 4.0 mA signal to prevent external alarms during calibration. In the case of local or remote Oxygen sensors, during CAL PURGE DELAY the output simulates a typical atmospheric reading of 20.8%. CAL MODE automatically exits if no keystrokes are detected after 5 minutes.

Follow these GASMAX EC calibration guidelines:

- Calibration accuracy is only as good as the calibration gas accuracy. GDS Corp calibration gases are traceable to NIST (National Institute of Standards and Technology).
- **Never use calibration gas that has passed its expiration date.**
- Check the SPAN GAS VALUE setting and make sure it matches the calibration gas. (See Fig. 6-2)
- Always use a GDS Corp calibration cup that completely surrounds the sensor head.
- Be sure to use ZERO AIR, a mixture of 21% oxygen and 79% nitrogen, as a zero reference unless you are certain that no target gas exists in the area. Ambient gas may result in an 'elevated zero' condition that will cause a FAULT to occur once the ambient gas is no longer present.
- **Always calibrate a new sensor before depending on the device for personnel or equipment safety**
- Calibrate on a regular schedule. GDS Corp recommends a full calibration every 3 months, with periodic 'bump tests' on a more frequent basis to ensure that the sensor has not been affected by temperature extremes or the presence of incompatible gases.

### Calibration Procedure

Before beginning calibration, make sure you have the following items: A cylinder of calibration gas, fixed flow regulator and an appropriate calibration cup connected to the regulator via a length of flexible tubing. If necessary, a cylinder of 'zero air' may be necessary if the absence of target gas cannot be confirmed. GDS Corp recommends a flow rate of 0.5 liters / minute for standard gases and a flow rate of 1.0 liters / minute for highly reactive gases such as chlorine or chlorine dioxide.

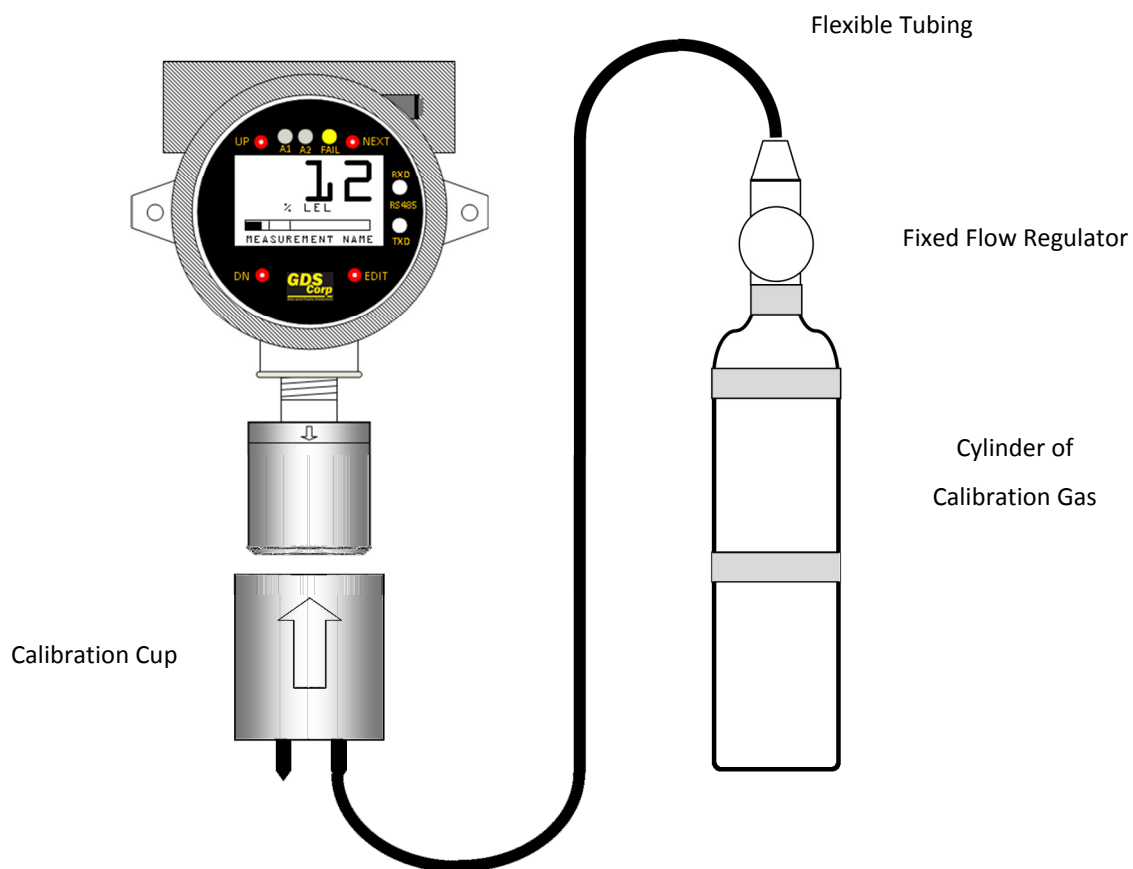

**Figure 5-1: Calibration Setup**

To calibrate a GASMAX EC detector:

1. To enter CAL MODE, press the DOWN / CAL key and within 5 seconds press the EDIT key.
2. The screen will display an APPLY ZERO message. Using the setup shown in Fig. 5-1, apply clean ZERO air unless it can be guaranteed that no target gas is present. After the reading stabilizes, press the EDIT key to complete the ZERO calibration.

3. If the ZERO CAL SUCCESSFUL message is displayed, an APPLY SPAN message will appear. Apply the correct SPAN gas. After the reading is stable, (approximately 1 minute) press the EDIT key to complete the SPAN GAS calibration. If the SPAN calibration is successful, the display flashes REMOVE CAL GAS and starts the CAL PURGE delay.
4. Immediately shut off the regulator and remove the calibration cup. At the end of the CAL PURGE delay, the GASMAX EC output is re-enabled and the unit is fully operational.

The flow chart shown in Figure 5-2 illustrates the above procedure. UP, CAL, NEXT & EDIT labels indicate keystrokes using the magnetic wand. ZERO or SPAN calibration will fail if the readings exceed built-in limits for maximum allowable zero or minimum allowable span.

**NOTE: A CAL MODE INFO SCREEN IS AVAILABLE TO VIEW CERTAIN CAL MODE PARAMETERS DURING CALIBRATION. HOLD THE UP KEY FOR 5 SECONDS DURING CAL MODE TO DISPLAY THIS SCREEN.**

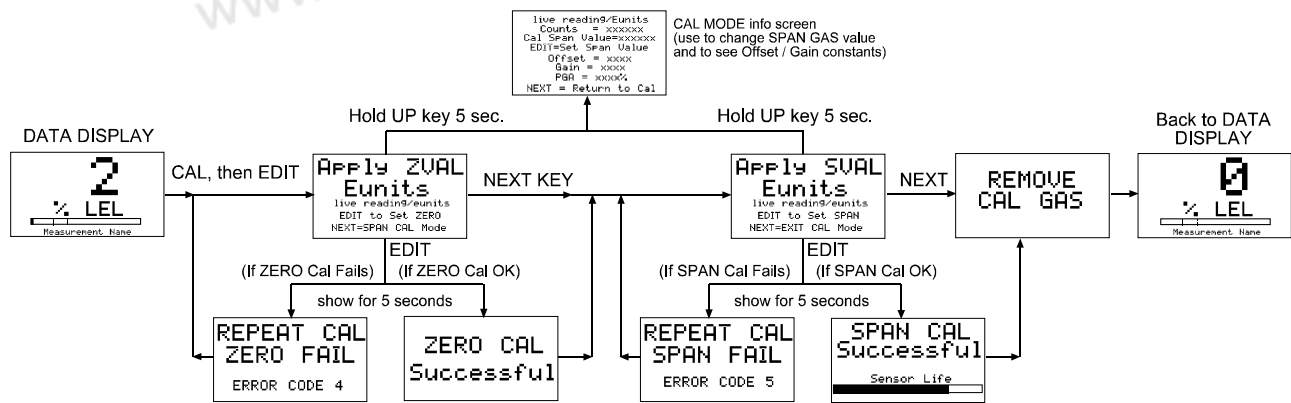

Figure 5-2: CALIBRATION FLOWCHART

## 6 OPERATION AND MAINTENANCE

### GASMAX Display Screens

The GASMAX display is shown in Figure 2-1. There are four magnetic switches on the face of the GASMAX, arranged in a quadrant around the LCD display. Starting in the upper right and proceeding clockwise these are labeled NEXT, EDIT, DOWN/CAL and UP.

To activate, or “press” a magnetic switch, swipe the magnet near the switch.

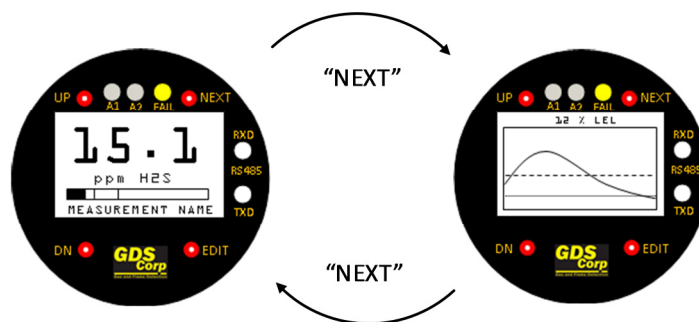

Figure 6-1: GASMAX EC Display Screens

Pressing the NEXT key causes the GASMAX display to switch display screens between DATA and TREND displays.

The EDIT key activates the USER MENU display mode. When in user menu display mode, use UP and DOWN to select an item, EDIT to change an item, and NEXT to exit the menu or function and return the GASMAX EC to display mode.

Activating DOWN/CAL, followed by EDIT, while in display mode initiates calibration mode. For the balance of this manual, the term “press” will be used to describe activation of any key via the magnetic wand.

### Data Display Screen

The DATA display screen shows a single channel’s information. The current value is shown in calibrated engineering units. A horizontal bargraph tracks the current value and shows the Alarm 1 and Alarm 2 values in graphical form. The user-programmable Engineering Units (“Eunits”) and Measurement Name text strings are shown below the real-time reading.

Above the LCD display, three LEDs indicate the status of the level and fault alarms.

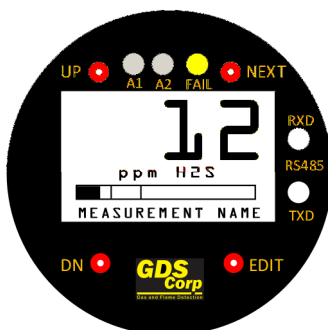

**Figure 6-2: GASMAX Data Display Screen**

### **Trend Display Screen**

The TREND display shows a graphical representation of the most recent 30 minute trend. The Alarm 1 level is shown as a closely spaced dotted line, and the Alarm 2 level is shown as a widely spaced dashed line.

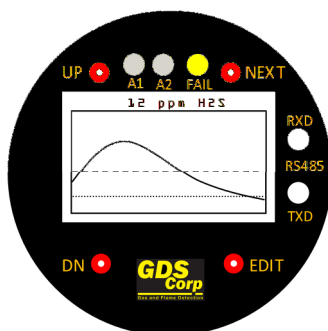

**Figure 6-3: GASMAX TREND Display Screen**

### **Normal Operation**

During normal operation, the GASMAX display shows the current gas reading in direct calibrated engineering units. If the reading goes above the Alarm 1 or Alarm 2 values, the front panel display LEDs will flash. The 4-20mA output (current sink) will transmit a value that represents the % of scale shown on the display. If the sensor malfunctions, or is removed, the Fault LED will illuminate and the message FAULT will appear on the display screen.

### **Alarm Operation – ALARM 1 and 2**

GASMAX EC's have front panel LED indicators for ALARM 1 and ALARM 2. Both alarm indicators can be set to activate above or below a given engineering units set point. Alarm processing will trigger an alarm

condition when the input exceeds the programmed value, and includes hysteresis to keep the alarm from rapidly switching ON and OFF if the input remains close to the programmed alarm value.

**NOTE: GASMAX EC ALARM SETTINGS AFFECT THE OPERATION OF THE FRONT PANEL LEDS ONLY. SEPARATE ALARM SETTINGS MAY NEED TO BE PROGRAMMED IN THE 4-20MA RECEIVING DEVICE.**

### **Alarm Operation – ALARM 3**

ALARM 3 is typically used to indicate FAULT conditions that suggest sensor failure or “out of measurement range” conditions. However, some applications require a third level alarm. The ALARM 3 menu is identical to ALARM 1 and ALARM 2 and may be set to trip at any level.

**NOTE: ALARM 3 WILL ALSO TRIP WITH MISSING OR FAILED SENSORS REGARDLESS OF THE PROGRAMMED LEVEL VALUE.**

### **Sensor Replacement**

If a sensor shows FAULT, does not respond to gas or can no longer be calibrated, it should be replaced. GASMAX EC monitors use GDS Corp type 10-95XX sensors, where the XX is the gas type shown in Section 3. The range value should also be specified when ordering replacement sensors. For example, a replacement H2S sensor for 0-100 ppm would be “10-9515-R0100”.

To replace a sensor, review Fig. 6-2 and follow these steps (See Fig. 6-4):

1. Declassify the area or remove power to the GASMAX EC.
2. Unscrew the sensor head cover. If unable to open the cover by hand, use a Sensor Head Replacement Tool (p/n 10-0187).
3. Remove the old sensor by pulling straight down.
4. Carefully install the replacement sensor by aligning the arrow on the sensor with the arrow engraved on the sensor head. Push straight up until the sensor connector seats firmly into the sensor connector.
5. Reinstall the sensor head cover by CAREFULLY screwing the cover onto the sensor head.

**NOTE: DO NOT TRY TO UNSCREW THE SENSOR. PULL STRAIGHT DOWN.**

**NOTE: IF THE SENSOR FALLS OUT OF THE SENSOR HEAD DURING THIS STEP, IT CAN BE DAMAGED. USE CAUTION WHEN REINSTALLING THE SENSOR HEAD COVER.**

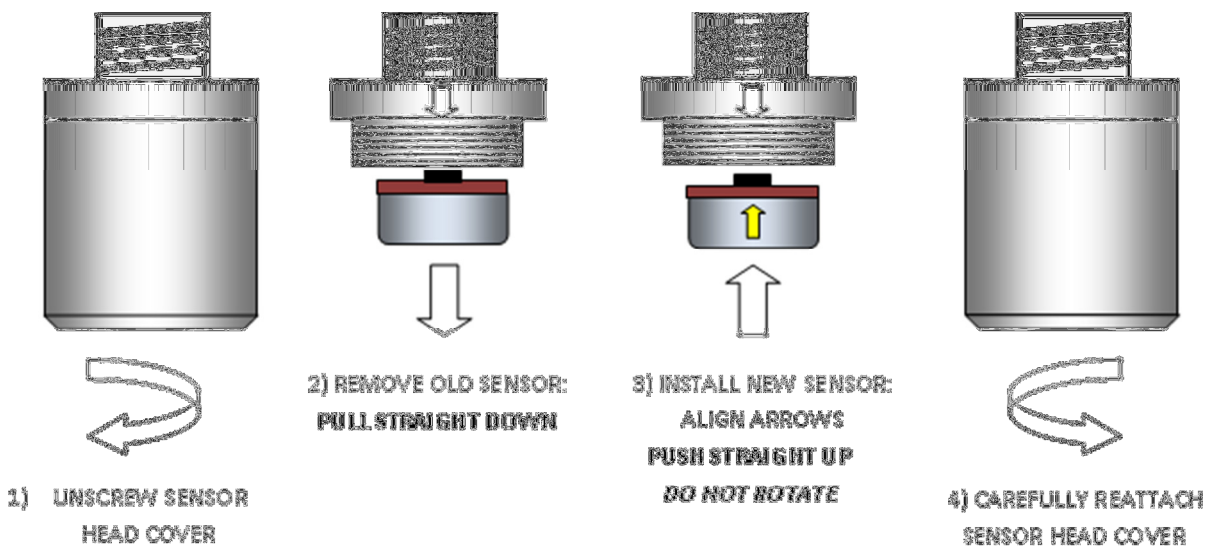

**Figure 6-4: Sensor Replacement**

Local Smart Sensors are automatically recognized by the GASMAX EC and the Smart Sensor identification screen shown in Figure 6-1 (left side) should appear immediately after the installation of a local Smart Sensor. If the sensor is the same gas type as was previously installed, the sensor's calibration data will be uploaded into the GASMAX EC. All other parameters stored in the GASMAX EC will be retained.

GASMAX EC units can be reconfigured for different sensors by simply installing a different type compatible sensor. If a new sensor TYPE is installed, the Smart Sensor identification screen will appear, followed by the ERROR CODE 01 message and the user will be given the opportunity to confirm the new sensor type. If the user activates the EDIT key, all data stored in the new sensor's database – including range, tag name, cal span value, engineering units and alarm levels – will replace the current settings.

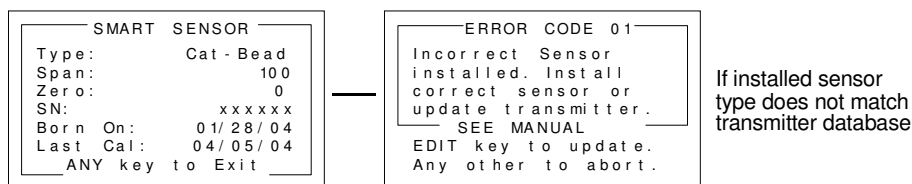

**Figure 6-5: SMART SENSOR Recognition Screen**



### **Sensor Replacement – Remote Sensors**

To replace a remote sensor, follow these steps:

1. Declassify the area or remove power to the GASMAX EC.
2. Unscrew the remote sensor head cover. If unable to open the cover by hand, use a Sensor Head Replacement Tool (p/n 10-0187).
3. Remove the old sensor by pulling straight down.  
**NOTE: DO NOT TRY TO UNSCREW THE SENSOR. PULL STRAIGHT DOWN.**
4. Carefully install the replacement sensor by aligning the arrow on the sensor with the arrow engraved on the sensor head. Push straight up until the sensor connector seats firmly into the sensor connector.
5. Reinstall the sensor head cover by CAREFULLY screwing the cover onto the sensor head.  
**NOTE: IF THE SENSOR FALLS OUT OF THE SENSOR HEAD DURING THIS STEP, IT CAN BE DAMAGED. USE CAUTION WHEN REINSTALLING THE SENSOR HEAD COVER.**
6. At the GASMAX EC, activate the Main Menu, open the Sensor Information page and select Install New Sensor. This will reset the Sensor Life settings and tell the GASMAX EC that a new sensor is available.  
**NOTE: If the new sensor is of a different TYPE, a number of other settings, including input type, range, cal span value and others may have to be changed. Contact GDS Corp for more information.**

### **Normal Maintenance**

Normal maintenance for the GASMAX EC primarily involves periodic calibration on standard intervals. GDS Corp recommends calibration at least every three months, or more often if temperature extremes, vibration, the presence of incompatible gases or other environmental factors may accelerate the deterioration of the sensor element. Calibration should also include inspections for clogged or wet sensor heads, cracked or damaged enclosures and water incursion inside conduit or junction boxes.

# 7 USER MENUS

## Main Menu

GASMAX EC setup variables are stored in non-volatile memory and can be modified by the end user to better match a particular application. The GASMAX EC Main Menu tree is shown below. To access the Main Menu, swipe the magnetic wand over the EDIT key.

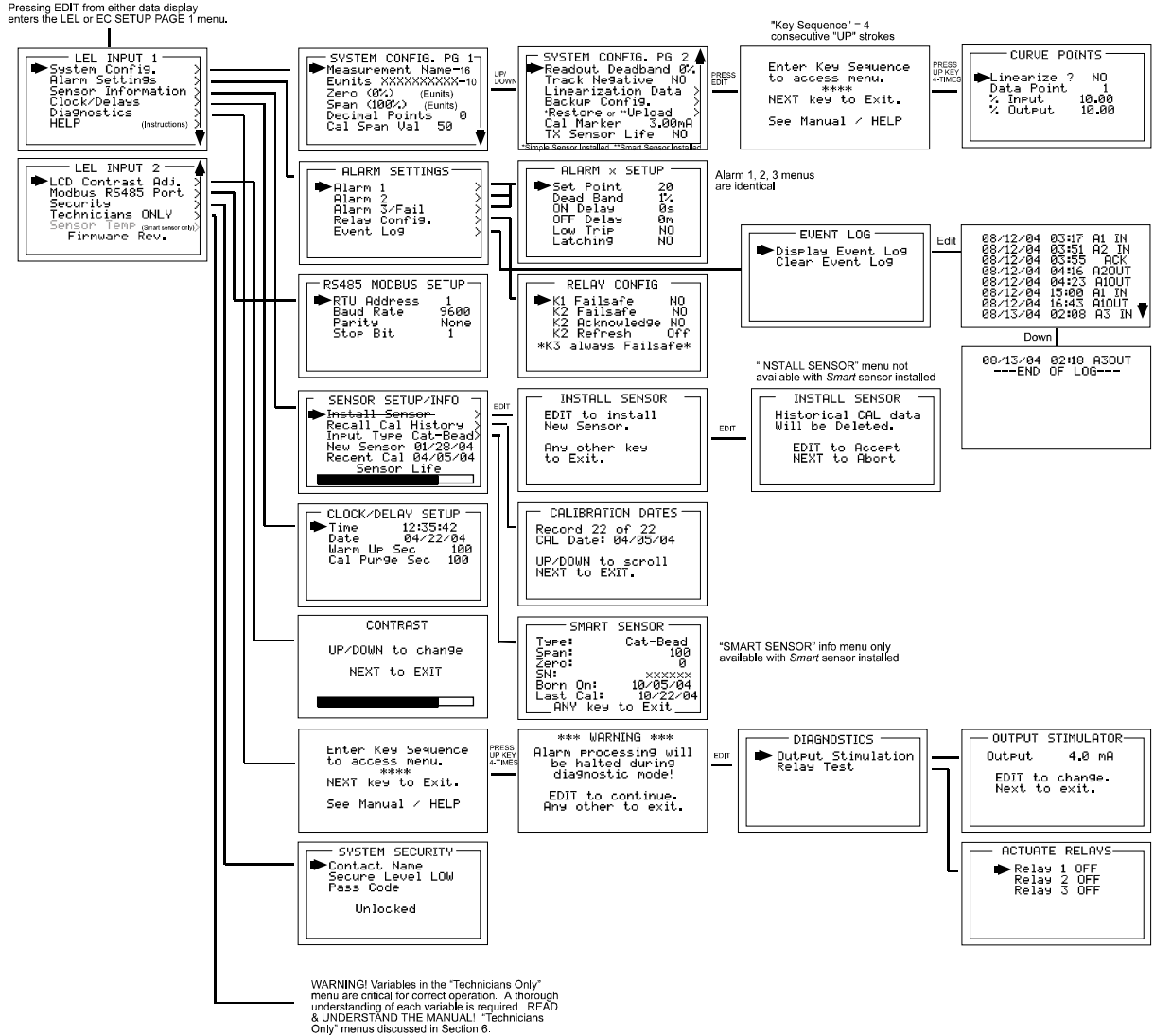

Figure 7-1: MAIN MENU FLOWCHART

## System Configuration Page

The System Config group consists of two pages of menus as shown in Figure 6-2. Each item's description follows in this section.

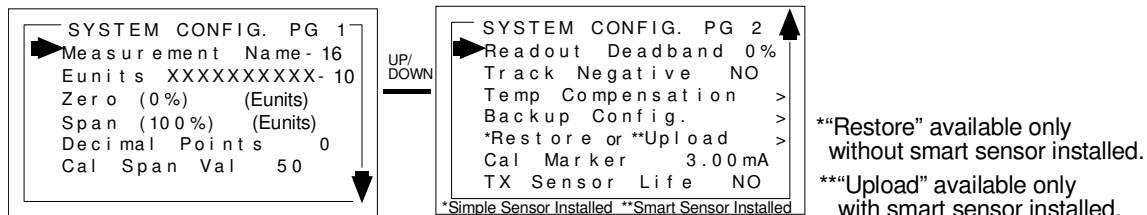

Figure 7-2: SYSTEM CONFIG MENU

**MEASUREMENT NAME** may be edited to contain virtually any 16-character field and is typically used to describe the monitored point by user tag number or other familiar terminology. To modify the existing setting, press the EDIT key when the cursor is pointing to the entry. Use the UP or DN keys to change the character, and the NEXT key to move to the next character. Press EDIT again when done.

**EUNITS** (engineering units) may have up to a 10 character ASCII field. Many common gases have pre-configured Eunits based upon the sensor type and each may be edited in this menu as described in Configuration Using the Magnetic Wand section 5-2.

**ZERO (0%)** defines the reading to be displayed when 4mA (0%) is the GASMAX EC output.

**SPAN (100%)** defines the reading to be displayed when 20mA (100%) is the GASMAX EC output. The highest reading allowed is 9999 including negative polarity sign. Polarity is only indicated for negative readings.

**DECIMAL POINTS** set the resolution of the LCD readings and may be set for 0, 1 or 2. For example, ZERO readings for 0, 1 & 2 decimal points displays as “0”, “0.0” & “0.00”.

**CAL SPAN VALUE** sets the engineering units value of the calibration gas. GDS Corp recommends that the calibration gas value be between 25% and 75% of full scale. Calibrating at 100% of scale is not recommended.

**READOUT DEADBAND** forces low values to continue to read zero. This is useful when there are small amounts of background gases that may cause fluctuating readouts. The highest amount of deadband allowed is 5%.

**NOTE: THE 4-20MA OUTPUT IS NOT AFFECTED BY THIS SETTING.**

**TRACK NEGATIVE** allows the display to show negative values when set to “YES”. This can be helpful when troubleshooting sensor problems. The default setting is “NO” and forces the display to read “0” if

the sensor value drops below zero. However, negative sensor outputs will always cause the Fault alarm to trip. The 4-20mA output always locks at 4mA when the reading drifts negative.

**TEMP COMPENSATION** adjusts sensor output based on ambient temperature. GDS Corp temperature compensated sensors are preprogrammed with the necessary table of values and are automatically uploaded to the GASMAX EC from the smart sensor. This menu item is not accessible unless a temperature compensated local Smart Sensor is installed.

**BACKUP CONFIG** allows users to store the entire current GASMAX EC menu database into non-volatile memory for restoration later if incorrect values are accidentally entered or uploaded.

**RESTORE CONFIG** restores the GASMAX EC menu database to the values from the most recent Backup Config. This menu item is only available if a smart sensor is not installed. The special keystroke sequence of 4 consecutive UP keys is also required to perform backup and restore operations.

**UPLOAD SENSOR DATA** allows the user to manually upload the entire smart sensor database to the GASMAX EC from the smart sensor.

**CAL MARKER** allows the user to set the 4-20mA output value that is transmitted during ZERO and SPAN calibration. This setting is limited to between 3ma and 20mA and is a useful way to indicate to a GDS controller that the unit is in CAL MODE.

**TX SENSOR LIFE** causes the GASMAX EC 4-20mA output to transmit a “sensor life” value after the completion of a successful calibration cycle. During normal operation, the GASMAX EC transmits a 4mA signal during the CAL PURGE delay to allow time for the span gas to dissipate. With TX Sensor Life = YES, the GASMAX EC transmits 4mA for the first 10 seconds, then for 5 seconds transmits a value between 4mA and 5mA, with 4mA equal to 0% sensor life and 5mA equal to 100% sensor life (see Figure 5-5). The output then returns to 4mA for the remainder of the CAL PURGE delay. For example, if after a calibration sensor life is 75%, the GASMAX EC transmits 4.75mA during the 5-second interval.

Note: TX Sensor Life should always be set for NO unless the 4-20mA receiver is capable of interpreting the sensor life signal. Most GDS Corp *Protector* Series controllers include this capability.

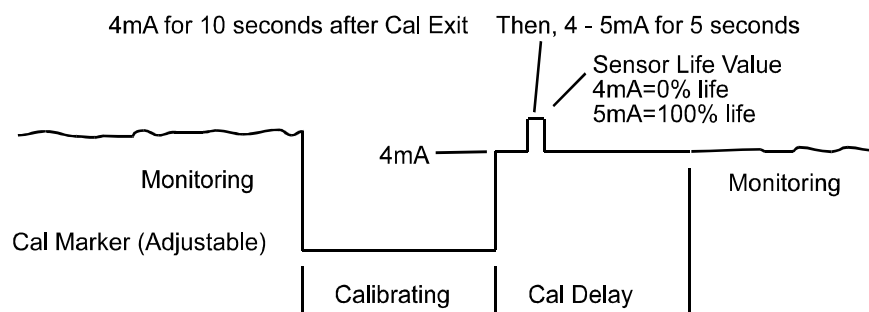

**Figure 7-3: SENSOR LIFE TRANSMISSION FORMAT**

## Alarm Settings Page

The Alarm Settings page covers the Alarm 1, 2, 3 Setup and Event Log menu items. Alarm 1, Alarm 2 and Alarm 3/Fail menus are identical and are therefore described only once in this section. For the GASMAX EC, the alarm settings only affect the operation of the front panel LEDs. Separate alarm settings may need to be programmed in the 4-20mA receiving device.

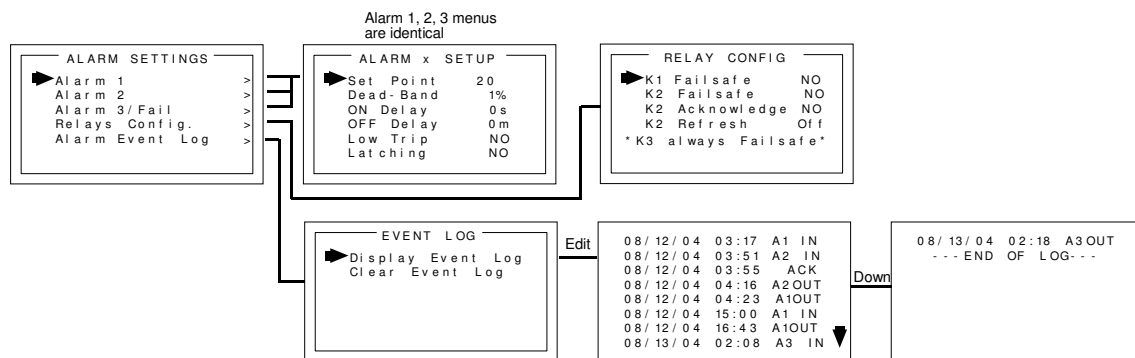

Figure 7-4: ALARM SETTINGS MENU

**SET POINT** enters the engineering unit value where the alarm trips. It may be negative and trip when monitored values fall out of range in this direction. A3 has a default setting of negative 10 with Low Trip set for YES. This makes it function as a FAULT alarm and trip when the monitored value falls to less than negative 10. It is important to adjust this value when the transmitter's span value is set for another value other than 100. For example, a typical span setting for monitoring oxygen level is 25 therefore the fault level value should be adjusted to -2.5 which is equal to negative 10% of full scale.

**DEAD-BAND** has a minimum value of 1% and a maximum value of 10%. It is useful for preventing alarm cycling when the monitored value is hovering around the set point. EXAMPLE: With a range of 0-100 ppm, if Dead-Band equals 5% and the set point is 20 ppm, after tripping at 20 ppm the value must drop below 15 ppm to reset.

**ON DELAY** allows entering a maximum 10 second delay before this alarm becomes active. This is useful for preventing nuisance alarms caused by brief spikes beyond the set point.

**OFF DELAY** allows entering a maximum 120 minute delay before clearing an alarm after the alarm condition is gone. This is useful for continuing an alarm function, such as operation of an exhaust fan, for a period of time after the alarm condition clears.

**LOW TRIP** set to YES causes the alarm to trip as the value falls below the set point.

**LATCHING** set to YES causes the alarm to remain active even after the condition is gone and only reset when the UP / RESET key is pressed from a data display.

**DISPLAY EVENT LOG** displays the stored events in the Event Log. These include power-on, cold-boot, alarms and alarm acknowledge events. The event log stores the date and time of the most recent 300 events.

**CLEAR EVENT LOG** clears the event log.

### Sensor settings page

The Sensor Information page covers settings associated with Smart or simple sensors. Users can review information contained in the Smart Sensor database, or adjust settings for remote simple sensors.

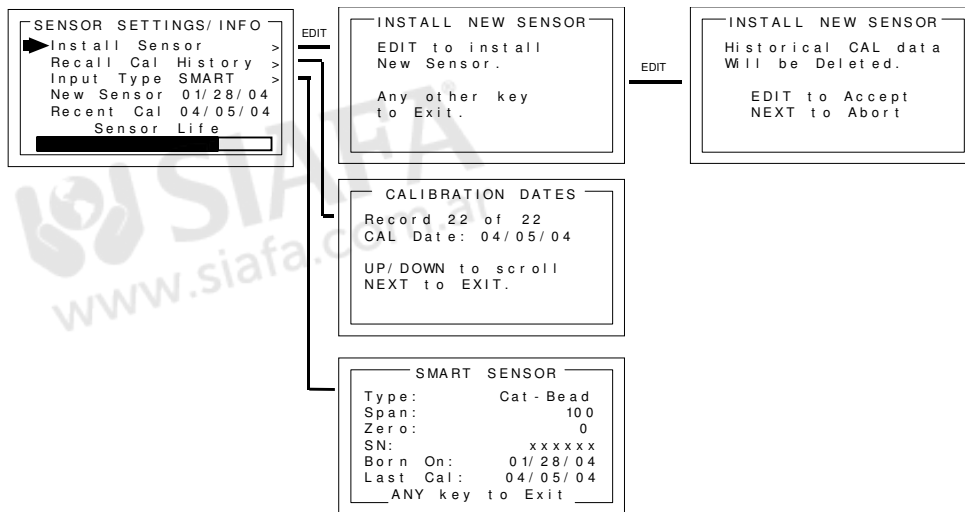

Figure 7-5: SENSOR SETTINGS MENU

**INSTALL NEW SENSOR** should always be performed when a new simple sensor is installed. This deletes historical CAL data and sets sensor life to 100% after initial calibration of the new simple sensor. The GASMAX EC Smart Sensor interface will automatically detect new Smart Sensors and this menu is therefore not available with a Smart Sensor connected.

**RECALL CAL HISTORY** recalls each successful calibration. These dates may be reviewed by scrolling with the UP / DOWN keys.

**INPUT TYPE** indicates what kind of input or sensor the GASMAX EC is configured to accept and is typically pre-configured at the factory. When installed, Smart Sensors upload sensor type and other data to the GASMAX EC and this data may be viewed on the SMART SENSOR information screen.

**NEW SENSOR** displays the date when a new sensor was last installed.

**RECENT CAL** displays the most recent calibration date.

### CLOCK/DELAY SETUP Page

The GASMAX EC is equipped with a crystal-controlled, battery-backed real-time clock that maintains local Time and Date. These values are factory preset to US Central Time and should be reset to correctly match the current time zone during installation to make sure that time-stamped Event Log entries are correct.

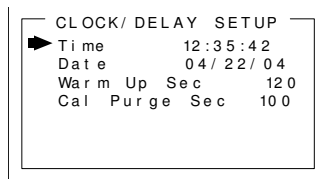

Figure 7-6: CLOCK DELAY MENU

**TIME** adjusts time of day in hours, minutes and seconds.

**DATE** adjusts date in month, day, year.

**WARM UP DELAY** sets the amount of time from power-on until the 4-20mA output signal begins to track the sensor output. Default setting is 60 seconds. Maximum value is 255 seconds.

**CAL PURGE DELAY** sets the amount of time from the completion of span calibration until the 4-20mA output signal restarts tracking the sensor output. The default setting is 60 seconds and the maximum value is 255 seconds.

### LCD CONTRAST Adjustment Page

The LCD Contrast Adjustment allows the display to be set for optimum viewing.

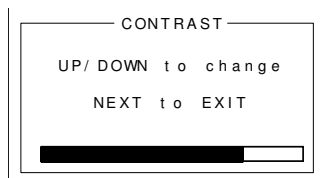

Figure 7-7: CONTRAST MENU

### HELP Screen Page

The Help screen contains several pages of information describing GASMAX EC operation.

### DIAGNOSTICS Page

The Diagnostics page provides tools for use during setup or testing. Since relays are not available on the GASMAX EC, the Relay Test option is not functional.

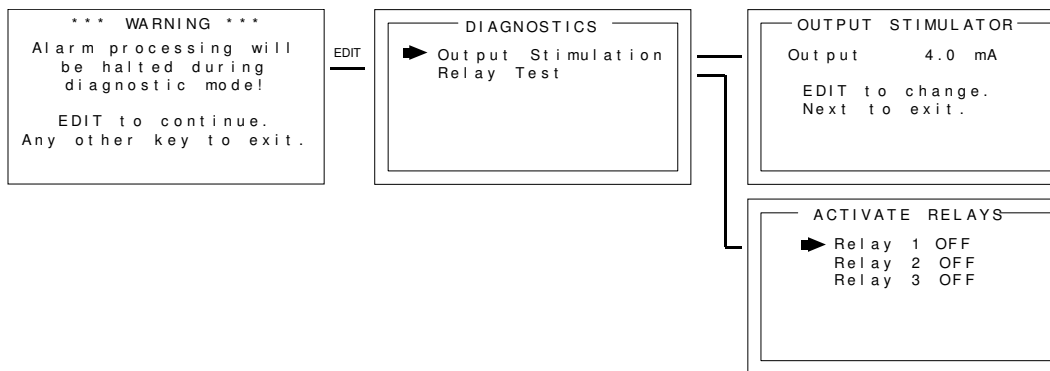

**Figure 7-8: DIAGNOSTICS MENU**

**OUTPUT SIMULATION** allows setting the 4-20mA output to virtually any desired value. This is useful for checking responses of devices receiving the GASMAX EC's 4-20mA output.

**RELAY TEST** is not supported on a GASMAX EC.

**WARNING:** GAS MONITORING AND ALARM PROCESSING ARE NOT PERFORMED WHILE USING THE DIAGNOSTICS MENUS. ACCESS REQUIRES A SPECIAL KEY SEQUENCE OF FOUR CONSECUTIVE UP KEYSTROKES.

### SYSTEM SECURITY Page

The System Security menu offers two levels of protection against operation by unauthorized personnel or those with malicious intent.

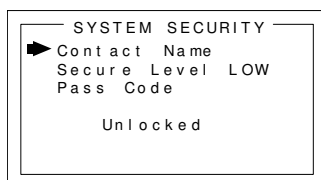

**Figure 7-9: SYSTEM SECURITY MENU**

**CONTACT NAME** is a 12 character ASCII field available for displaying a phone # or name of personal who knows the Pass Code. Lost Pass Codes may be recovered by entering the locked security menu and holding the UP key for 5 seconds. The 4-digit code appears near the bottom of the screen.

**SECURE LEVEL** sets LOW, HIGH or OFF modes. A LOW level allows CAL MODE sensor calibrations but requires the 4-digit Pass Code prior to altering menus. HIGH level locks the entire menu database and the CAL Mode until the correct Pass Code is entered. LOW and HIGH security levels always allow static viewing of configuration menus.



## 8 TECHNICIANS MENU

The TECHNICIANS MENU group consists of the XMITTER CONFIG menu and TECHNICAL PAGE menu. These menus contain items that are typically factory configured depending upon the type sensor and input connected. Care should be used when modifying these variables as some items will prevent proper operation and could endanger personnel. Access requires a special key sequence of four UP keystrokes to prevent accidental modification of critical items.

### XMITTER CONFIG Menu

The XMITTER CONFIG menu is used to activate channels, precisely calibrate 4-20mA outputs and set time / date. To access the XMITTER CONFIG menu, press and hold the NEXT key for 5-seconds until the screen appears requesting the special key sequence.

**WARNING:** TARGET GAS MONITORING AND ALARM PROCESSING ARE NOT ACTIVE WHILE IN THIS MENU.

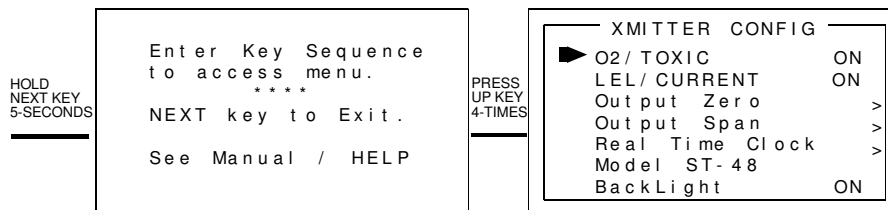

Figure 8-1: XMITTER CONFIG MENU

**O2 / TOXIC** when set to YES enables the Oxygen / Toxic channel.

**LEL / CURRENT** is not available in the GASMAX EC.

**OUTPUT ZERO / SPAN TRIM** provides a way to precisely set the GASMAX EC 4mA and 20mA outputs to compensate for variation in output components. These settings are programmed at the factory and should not be modified.

**REAL TIME CLOCK** adjusts the date and time for use in EVENT LOGGING. The current time and date can also be adjusted from the Main Menu (See Section 7).

**MODEL** is factory set and should not be modified.

**BACKLIGHT** is not available in the GASMAX EC.

## TECHNICAL PAGE Menu

The TECHNICAL PAGE menu is used to adjust certain parameters associated with local or remote sensors. To access the TECHNICAL PAGE menu, active the Main Menu, move the cursor to the second page and select Technicians Only. Enter the special key sequence to enter the TECHNICAL PAGE menu.

**WARNING: TARGET GAS MONITORING AND ALARM PROCESSING ARE NOT ACTIVE WHILE IN THIS MENU.**

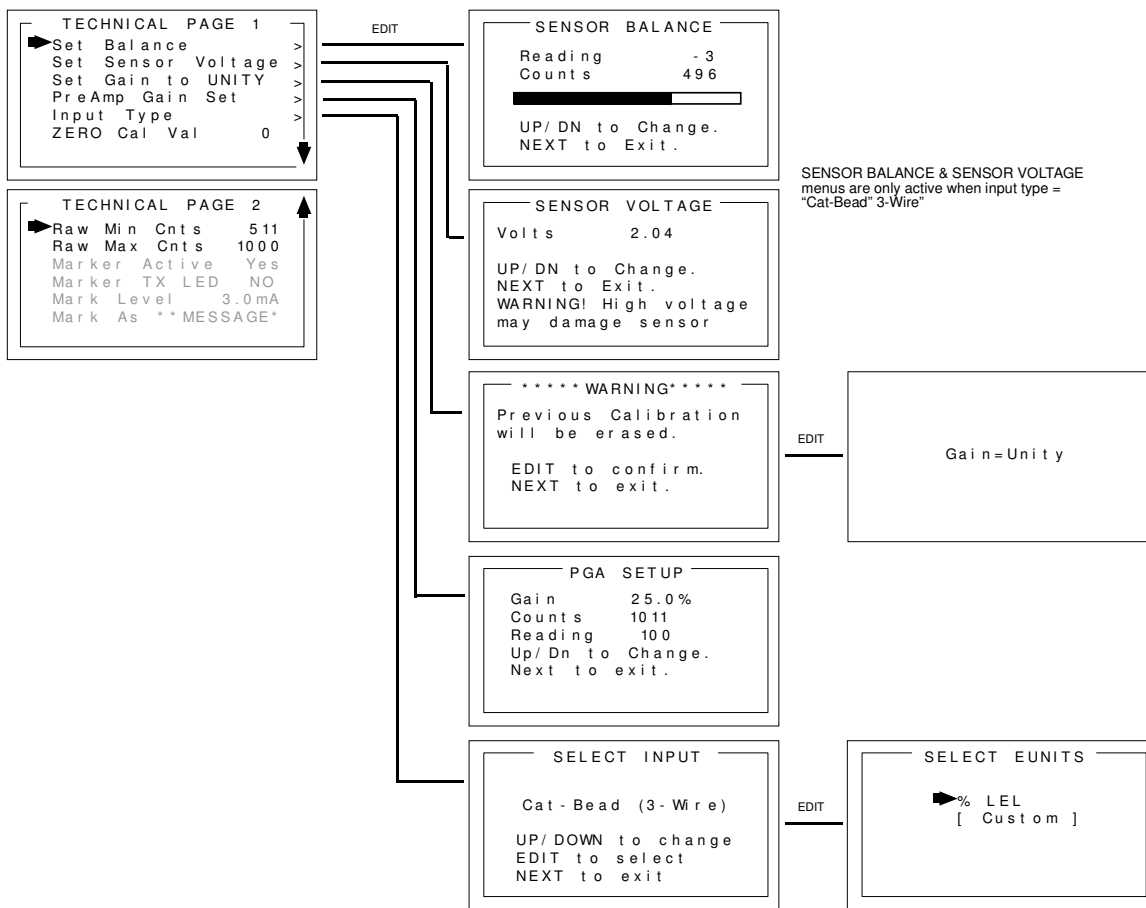

**Figure 8-2: TECHNICAL PAGE MENU**

**SET BALANCE** is for use with bridge-type sensors and is not available on the GASMAX EC.

**SET VOLTAGE** is for use with bridge-type sensors and is not available on the GASMAX EC.

**SET GAIN TO UNITY** clears any previous calibration OFFSET and GAIN values to "0.0" and "1.0", respectively. This item is useful if a previous calibration was done in error, or if screen readings appear incorrect for no apparent reason.

**WARNING: A FULL CALIBRATION SHOULD ALWAYS BE PERFORMED AFTER A SET GAIN TO UNITY COMMAND.**

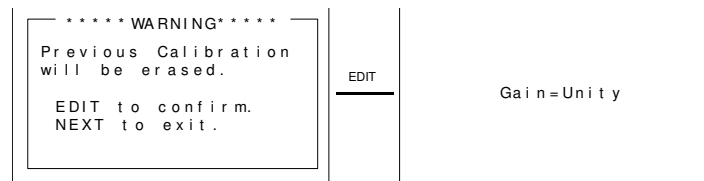

**Figure 8-3: SET GAIN TO UNITY MENU**

**PREAMP GAIN SET** allows adjustment of the analog amplifiers that match the sensor output to the optimum input range for the GASMAX EC signal conditioning circuits. Local Smart Sensors include factory-preset preamp gain values and for standard sensors and applications, these values should not be changed. For remote simple sensors or for situations where a local Smart Sensor does not quite provide enough signal to successfully complete a SPAN calibration, the Preamp gain can be adjusted using the UP / DOWN keys. GDS Corp does not recommend adjusting the Preamp Gain to any value higher than 85%.

**WARNING: A FULL CALIBRATION SHOULD ALWAYS BE PERFORMED AFTER ANY CHANGE IN THE PREAMP GAIN SETTING.**

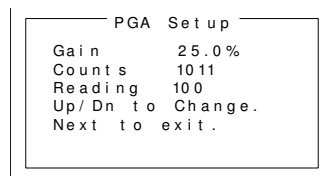

**Figure 8-4: PREAMP GAIN SET MENU**

**INPUT TYPE** Local Smart Sensors automatically configure Input Type to match sensor requirements. However, when using remote sensors, Input Type must be set manually. Input Type is factory preset and should not be changed unless a different TYPE remote sensor is to be installed. Input Type configures GASMAX EC hardware to accept bridge sensors, positive coefficient electrochemical sensors, negative coefficient electrochemical sensors or 4-20 mA inputs.

After selecting Input Type, a SELECT EUNITS screen indicates the default engineering units for this sensor.

Coefficient	Electrochemical Sensor Type	Default EUNITS
Negative	Hydrogen Sulfide	ppm H <sub>2</sub> S
Negative	Oxygen	% Oxygen
Negative	Carbon Monoxide	ppm CO
Negative, Bias	Ammonia	ppm NH <sub>3</sub>
Negative, Bias	Nitric Oxide	ppm NO
Negative	Ethylene Oxide	ppm Eth O <sub>2</sub>
Negative	Hydrogen Chloride	ppm HCL
Negative	Hydrazine	ppm N <sub>2</sub> H <sub>4</sub>
Negative	Arsine	ppm Arsine
Negative	Sulfur Dioxide	ppm SO <sub>2</sub>
Negative	Hydrogen	ppm H <sub>2</sub>
Negative	Hydrogen Cyanide	ppm HCN
Negative	Phosgene	ppm COCl <sub>2</sub>
Negative	Phosphine	ppm PH <sub>3</sub>
Negative	Hydrogen Fluoride	ppm HF
Positive	Nitrogen Dioxide	ppm NO <sub>2</sub>
Positive	Ozone	ppm Ozone
Positive	Chlorine	ppm Cl <sub>2</sub>

**ZERO CAL VALUE** should always be set to "0".

**RAW MIN / MAX COUNTS** is factory preset and should not be changed.

**MARKER MENU** functions are not available on the GASMAX EC.

## 9 TROUBLESHOOTING GUIDE

### Toxic Sensor Indicates Fault or Overrange

- Certain toxic sensors indicate off-scale low or high at power up and quickly drift towards zero. This is normal behavior.
- Toxic sensors showing constant FAULT: If local, remove sensor and examine for moisture or discoloration. Replace sensor if wet or discolored. If remote, check sensor cable and junction box for moisture or standing water. Remove sensor and examine for moisture or discoloration. FAULT indication generally indicates sensor useful life is exhausted.
- Toxic sensors left unpowered for more than 3 months are subject to accelerated degradation and may demonstrate a permanent loss of sensitivity.

### Toxic Sensor Will Not Calibrate

- Sensor reading during zero calibration exceeds upper limit of zero – sensor is defective and should be replaced.
- Sensor reading during span calibration too low – sensor may be defective. However, it may be possible to temporarily continue operation by increasing PREAMP GAIN. See Section 8.2 for more details.

### Receiving Device and GASMAX Displayed Values Don't Match

- Check that zero and full scale range values match between GASMAX and receiving device (controller). Use DIAGNOSTICS menu to force GASMAX EC output to 12mA (1/2 scale) and verify appropriate half-scale reading on controller.
- Check for high impedance shorts to ground on 4-20mA wiring.
- If 4-20mA output is off-scale low or high and cannot be adjusted using DIAGNOSTICS mode, IO/Power Supply board may be defective and should be replaced.

### GASMAX Display Blank

- Verify DC loop power at back of Display Assembly.

### GASMAX Error Codes

- 01 – Incorrect sensor type – new sensor does not match most recent type of sensor. This is normal if changing sensor types. If unexpected, verify that new sensor type matches previous sensor type.
- 02 – Zero or span mismatch. Smart sensor zero or span values differ from those stored in the GASMAX.

- 03 – Sensor Calibration Error – Contact factory.
- 04 – Zero calibration failure – Zero readings must be within 10% of zero. For example, if the range is 0-100 ppm, the zero reading cannot be above 10 ppm. For bridge-type sensors, it may be possible to readjust the balance to restore a zero reading. Toxic sensors with high zero readings must be replaced.
- 05 – Span calibration failure – Span readings must be within a range of from ½ to 2x the target value. For example, if the target is 50 ppm, the sensor must output at least 25 ppm and no higher than 100 ppm at the current preamp gain setting for calibration to proceed.
- 06 – History data file full. Clear event log to remove.
- 07 – Sensor Channel Data CRC Fail – Error in sensor data transfer. Contact factory.
- 08 – System Data CRC Fail – Error in system data file. Contact factory.
- 09 – Custom Data CRC Fail – Error in system data file. Contact factory.
- 10- Linearization Data CRC Fail – Error in system data file. Contact factory.

## 10 SPARE PARTS

### Display & Enclosure

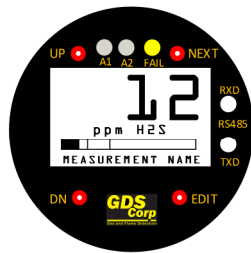

**Display:**  
10-0232 GASMAX Display

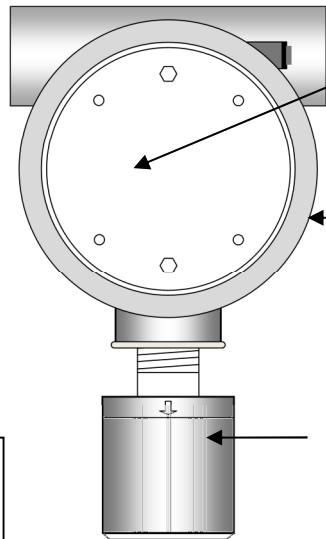

**Base plate with standoffs:**  
10-0262 All

**Yellow Enclosure:**  
10-0160 GASMAX Enclosure

**Sensor Head:**  
10-0247 Toxic or Bridge Direct (Type 1-2)  
10-0247F Toxic Direct / Reactive Gas (Type 3-4)  
Note: Does not include sensor

Figure 10-1: GASMAX EC + Local Sensor Spare Parts

### Sensor Head Accessories

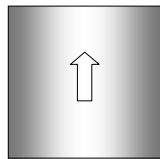
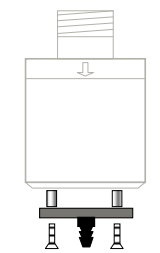

Splash Guard

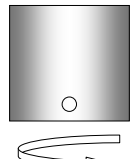
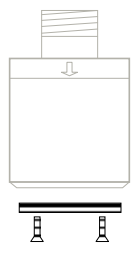

Flow Cell

**Sensor Head Splash Guard**  
10-0198 Splash Guard (Fits all sensor heads)

**Sensor Head Flow Cell**  
10-0205 Flow Cell (1/8" NPT compression fittings)  
20-0205S Other (specify)

Figure 10-2: GASMAX Sensor Head Splash Guard & Flow Cell

## Remote Sensor

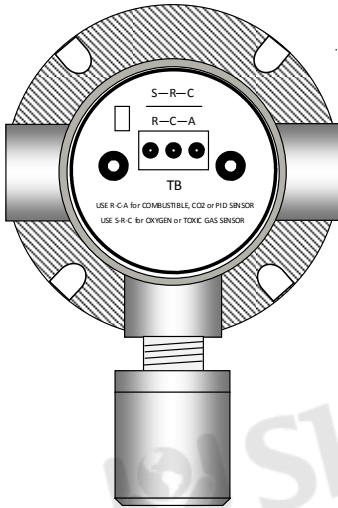

### Remote Sensor Head Assembly:

20-0126 Remote Toxic or Bridge Direct (Type 5-6)

20-0127 Remote Toxic / Reactive Gas (Type 7-8)

Note: Does not include sensor

Figure 10-3: GASMAX EC Remote Direct Sensor Head



## 11 DRAWINGS AND DIMENSIONS

